

# Panasonic®

5.8 GHz Digital Cordless Answering System

## Operating Instructions

Model No. **KX-TG5480**

Pulse-or-tone dialing capability

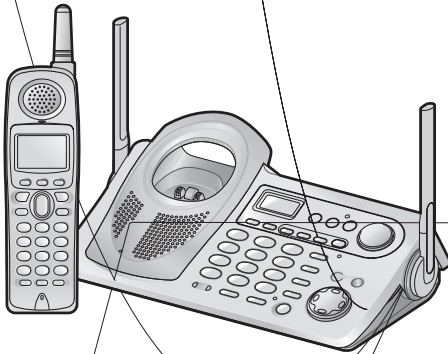

**2LINE**



The unit is Caller ID compatible. To display the caller's name and phone number, you must subscribe to Caller ID service.

**PLEASE READ BEFORE USE AND SAVE.**

**Charge the battery for 6 hours before initial use.**

**Panasonic World Wide Web address: <http://www.panasonic.com>  
for customers in the USA or Puerto Rico**





# Contents

---

## *Preparation*

<b>Location of Controls</b> . . . . .	<b>6</b>
<b>Displays</b> . . . . .	<b>9</b>
<b>Installation</b> . . . . .	<b>11</b>
Connecting the AC Adaptor . .	11
Connecting the Telephone Line Cord. . . . .	12
Installing the Battery in the Handset. . . . .	15
Battery Charge . . . . .	15
<b>Programmable Settings</b> . . . . .	<b>17</b>
Programming Guidelines. . . . .	17
Function Menu Table . . . . .	18
Date and Time. . . . .	19
Display Language . . . . .	20
Dialing Mode . . . . .	20
Line Mode . . . . .	21
Auto Talk. . . . .	22
LCD Contrast . . . . .	22
Ringer Volume . . . . .	23
Ringer Tone . . . . .	25
<b>Preparing the Answering System</b> . . . . .	<b>27</b>
Greeting Message. . . . .	27
Caller's Recording Time . . . . .	29
Number of Rings . . . . .	30
Recording Mode . . . . .	31
Message Alert . . . . .	31

## *Telephone System*

<b>Making Calls</b> . . . . .	<b>32</b>
Using the Handset. . . . .	32
Using the Base Unit . . . . .	36
<b>Answering Calls</b> . . . . .	<b>38</b>
<b>Using the Other Line During a Conversation</b> . . . . .	<b>39</b>

<b>Caller ID Service</b> . . . . .	<b>40</b>
<b>Using the Caller List</b> . . . . .	<b>41</b>
Viewing the Caller List. . . . .	41
Calling Back from the Caller List . . . . .	42
Editing the Caller's Phone Number . . . . .	43
Caller ID Number Auto Edit . .	44
Storing Caller Information in the Phone Book. . . . .	45
Erasing Caller Information. . . .	45
<b>Phone Book</b> . . . . .	<b>46</b>
Storing Names and Numbers . . .	46
Dialing from the Phone Book. .	47
Chain Dial . . . . .	49
Editing an Item in the Phone Book. . . . .	50
Erasing an Item in the Phone Book. . . . .	50
<b>Speed Dialer</b> . . . . .	<b>51</b>
Storing Phone Numbers . . . . .	51
Dialing a Stored Phone Number . . . . .	51
<b>Intercom</b> . . . . .	<b>52</b>
Making Intercom Calls. . . . .	52
Answering Intercom Calls . . . .	53
<b>Transferring a Call</b> . . . . .	<b>54</b>
<b>Conference Calls</b> . . . . .	<b>56</b>
Call Share . . . . .	57
<b>Special Features</b> . . . . .	<b>58</b>
Muting Your Conversation. . . .	58
Call Privacy . . . . .	58
Using the PAUSE Button (For PBX Line/Long Distance Calls). . . . .	58

Temporary Tone Dialing (For Rotary or Pulse Service Users) . . . 59  
 For Call Waiting Service Users . . . . . 59  
 FLASH Button . . . . . 60  
 Incoming Call Tone . . . . . 61  
 Line Selection . . . . . 62  
 Key Tone . . . . . 63  
 Re-registering the Handset . . . 64

## Answering System

**Automatic Answering Operation** . . . . . 65  
 Setting the Unit to Answer Calls . . . . . 65  
 Monitoring Incoming Calls . . . 66  
**Listening to Messages** . . . . . 67  
 Using the Base Unit . . . . . 67  
 Using the Handset (Remote Operation) . . . . . 68  
**Erasing Messages** . . . . . 71  
**Recording a Memo Message** . . . . . 72  
**Transferring a Call to the Answering System** . . . . . 73  
**Remote Operation from a Touch Tone Phone** . . . . . 74  
 Remote Code . . . . . 75  
 Voice Menu . . . . . 76  
 Direct Remote Operation . . . . . 77

## Useful Information

**Wall Mounting** . . . . . 78  
**Belt Clip** . . . . . 81  
**Optional Headset** . . . . . 81  
**Direct Commands** . . . . . 82  
**If the Following Appear on Your Display...** . . . . . 84  
**Troubleshooting** . . . . . 85

**Important Safety Instructions** . . . . . 90  
**FCC and Other Information** . . . 91  
**Specifications** . . . . . 94  
**Warranty** . . . . . 95  
**Index** . . . . . 97

**Important**

Throughout these Operating Instructions, **Handset** and **Base Unit** are used to indicate with which unit an operation can be performed.

**Handset** : Perform with the handset.  
**Base Unit** : Perform with the base unit.  
**Handset Base Unit** : Perform with the handset and base unit separately.  
**Handset & Base Unit** : Perform with the handset and base unit together.

Preparation

Telephone System

Answering System

Useful Information

# Location of Controls

---

Base unit LINE SELECT LINE SELECT AUTO AUTO ER.

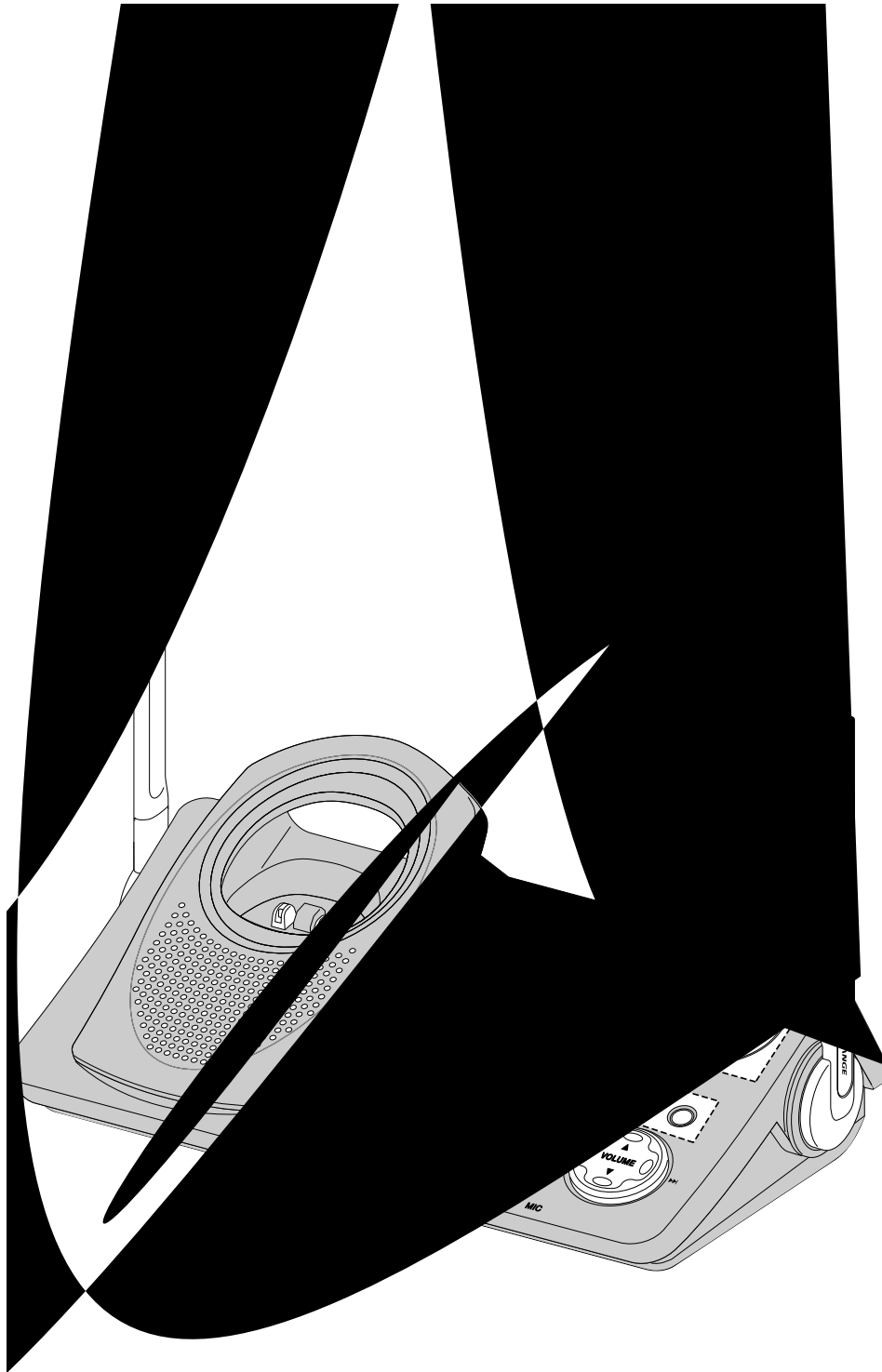

# Location of Controls

## Handset

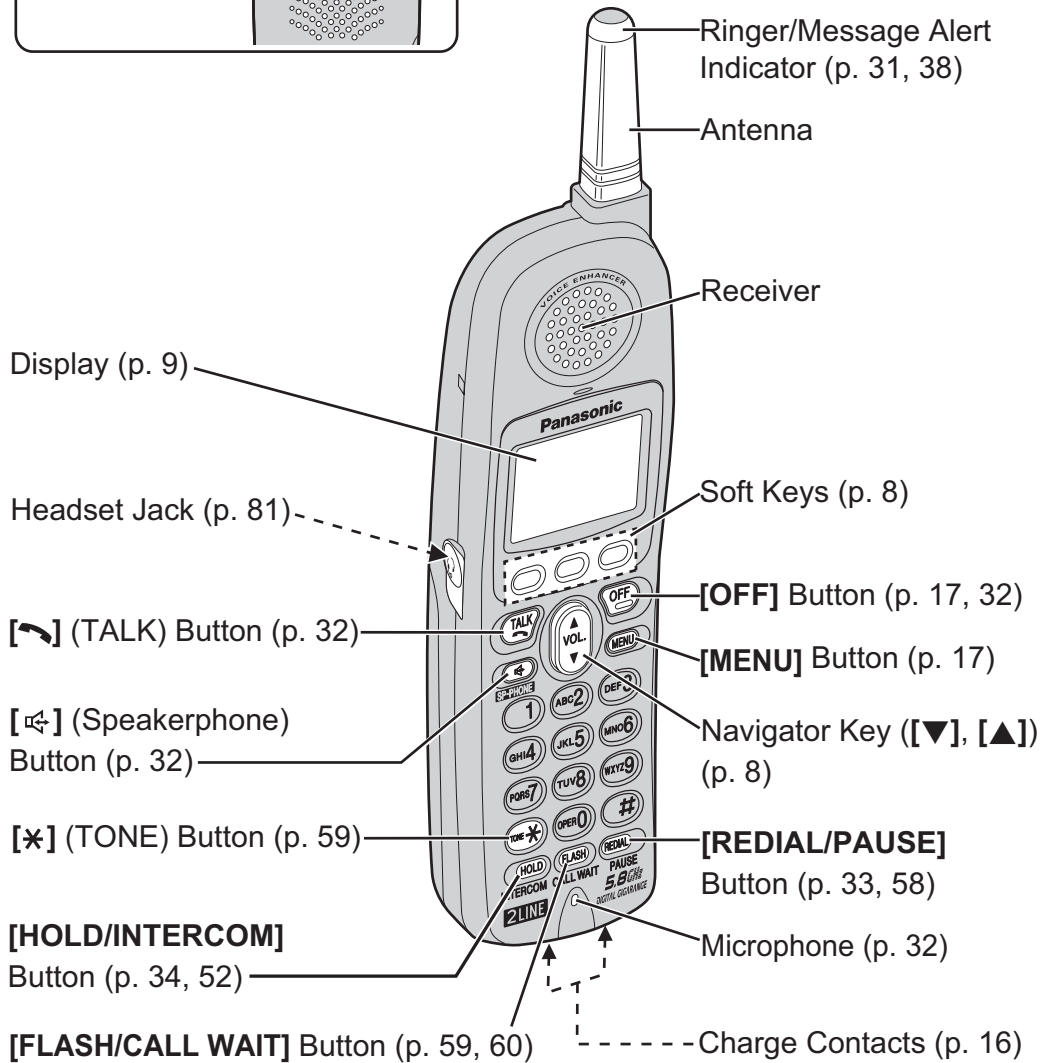
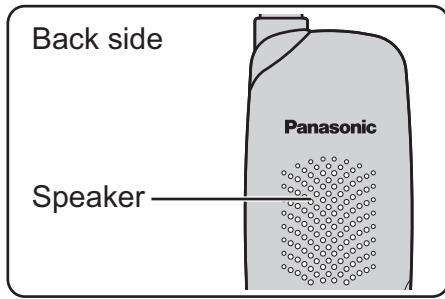

# Location of Controls

## How to use the soft keys/navigator keys

### Handset soft keys

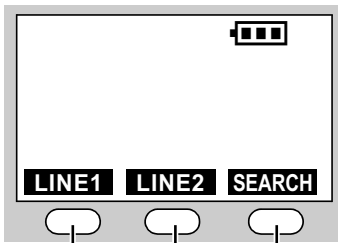

3 soft keys are used to select functions displayed directly above each key. Functions displayed above each key will change depending on the state of use.

On this sample display, “**LINE1**”, “**LINE2**” and “**SEARCH**” are displayed above the soft keys.

Pressing the right soft key selects “**SEARCH**”.

Pressing the middle soft key selects “**LINE2**”.

Pressing the left soft key selects “**LINE1**”.

- When a function name does not appear above a soft key, the soft key has no function.

Throughout these Operating Instructions, the soft keys are indicated by their icons, such as **LINE1**, **LINE2** and **SEARCH**.

### Handset navigator key



Scrolls up [▲] and down [▼] the function menu, the Caller List and the phone book.

Increases [▲] or decreases [▼] the handset ringer and receiver/speaker volumes.

Throughout these Operating Instructions, the handset navigator key is indicated by the arrows [▼] and [▲].

### Base unit navigator key

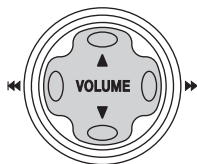

Increases [▲] or decreases [▼] the base unit speaker volumes.

Increases [▲] or decreases [▼] the base unit ringer volume for the line after pressing **[LINE SELECT]** (p. 24).

[◀◀] and [▶▶] select the base unit ringer tone for the line after pressing **[LINE SELECT]** (p. 26).

Repeats [◀◀] or skips [▶▶] recorded messages.

Throughout these Operating Instructions, the base unit navigator key is indicated by the arrows [▼], [▲], [◀◀] and [▶▶].



# Displays

## Handset

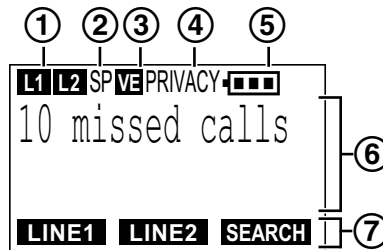

① “**L1**” and “**L2**” indicate the status of each line as follows:

Off (invisible)	The line is free.
On	The line is being used.
Flashing	A call is on hold on the handset or base unit, or the Answering System is answering a call (p. 65).
Flashing rapidly	A call is being received.

- ② “**SP**” is shown when you are using the handset speakerphone.
- ③ “**VE**” indicates Voice Enhancer mode is on (p. 35).
- ④ “**PRIVACY**” indicates Call Privacy mode is on (p. 58). The base unit user cannot join your conversation.
- ⑤ The battery icon indicates battery strength (p. 15).
- ⑥ The display shows the dialed number, call status, programming options, phone book items, Caller ID information, etc.
- ⑦ The icons on the bottom line indicate the functions of the corresponding soft keys which are located directly below the display (p. 8).

# Displays

## Base unit

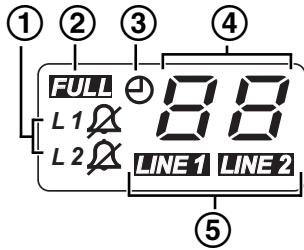

- ① “L 1” indicates the line 1 ringer on the base unit is off (p. 24).  
“L 2” indicates the line 2 ringer on the base unit is off (p. 24).
- ② “FULL” flashes when no new messages can be recorded. Erase unnecessary messages (p. 71).
- ③ “⌚” flashes until you set the date and time, and flashes after a power failure. If it is flashing, set the date and time (p. 19).
- ④ Message counter shows:
- the number of recorded messages (p. 67). If the recording time is set to “Greeting only”, “88” will be displayed for a few seconds when you turn the Answering System on (p. 65).
  - the selected volume level while you are adjusting the speaker volume (p. 28, 36).
  - “P” when [PROGRAM] is pressed to store a phone number (p. 51).
  - “E” when your greeting message or memo message was not recorded correctly (p. 27, 72).
- ⑤ “LINE 1” and/or “LINE 2” will be displayed when selecting the line(s)
- a) to record the greeting message (p. 27);
  - b) to turn the Answering System on (p. 65);
  - c) to play back messages (p. 28, 67);
  - d) to erase messages (p. 71);
  - e) to change the ringer volume or tone (p. 24, 26).
- “LINE 1” and/or “LINE 2” will flash when
- a) the Answering System is answering a call on the line (p. 65);
  - b) a message on the line is played (p. 67).

# Installation

## Connecting the AC Adaptor

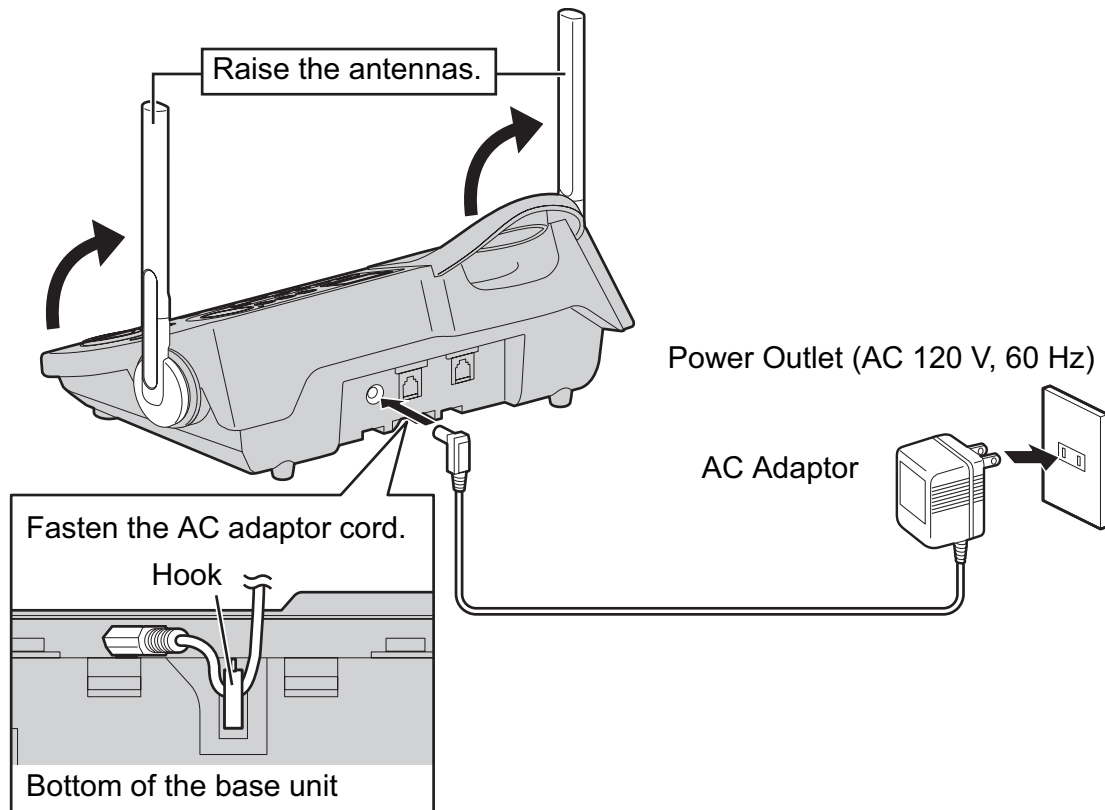

- USE ONLY WITH Panasonic AC ADAPTOR PQLV1 (Order No. PQLV1Z).
- The AC adaptor must remain connected at all times. (It is normal for the adaptor to feel warm during use.)
- The AC adaptor should be connected to a vertically oriented or floor-mounted AC outlet. Do not connect the AC adaptor to a ceiling-mounted AC outlet, as the weight of the adaptor may cause it to become disconnected.
- If your unit is connected to a PBX which does not support Caller ID, you cannot access Caller ID services.
- This unit will not function during a power failure. We recommend connecting a standard telephone to the same telephone line or to the same telephone jack using the Panasonic KX-J66 T-adaptor. We recommend connecting a noise filter (contact your DSL service provider) to the telephone line between the base unit and the telephone line jack.

# Installation

## Connecting the Telephone Line Cord

Connect the telephone line cord(s) to the base unit.

If your unit is connected to a telephone line with DSL service, see page 14.

### To connect to a 2-line telephone jack

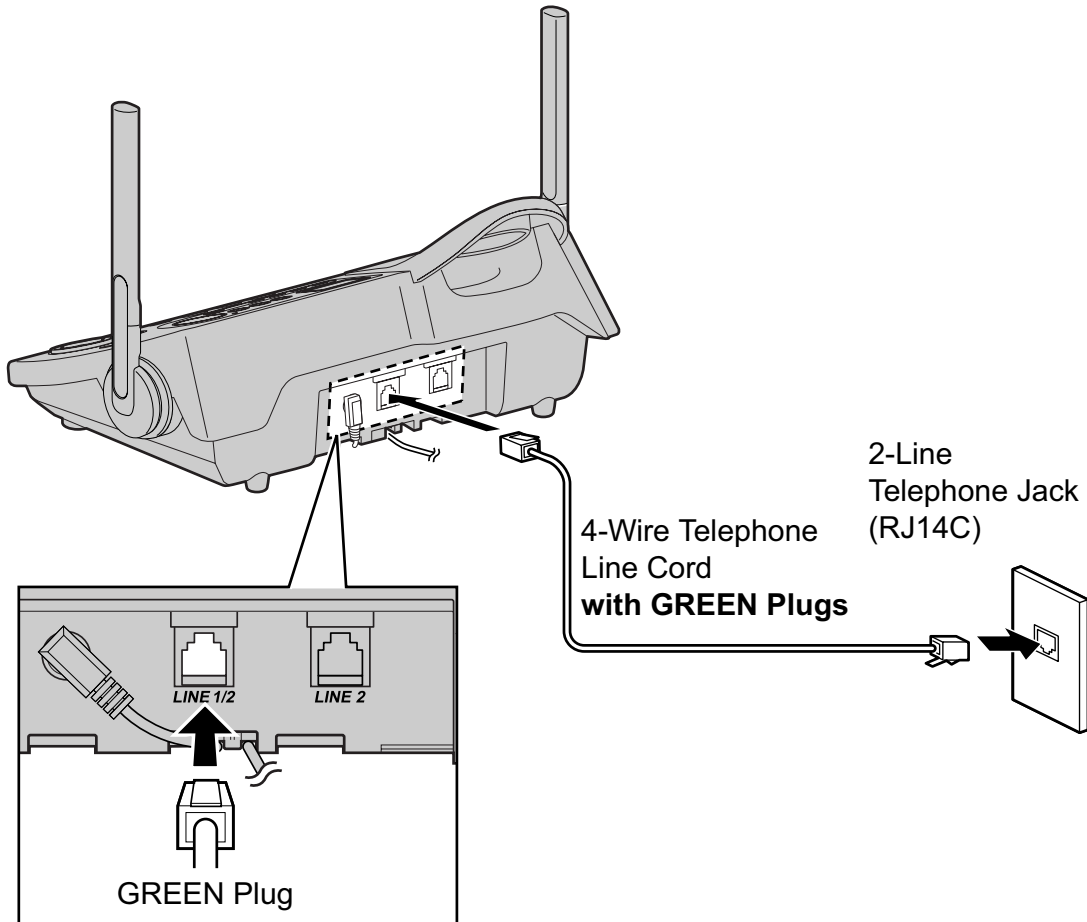

## To connect to 2 single-line telephone jacks

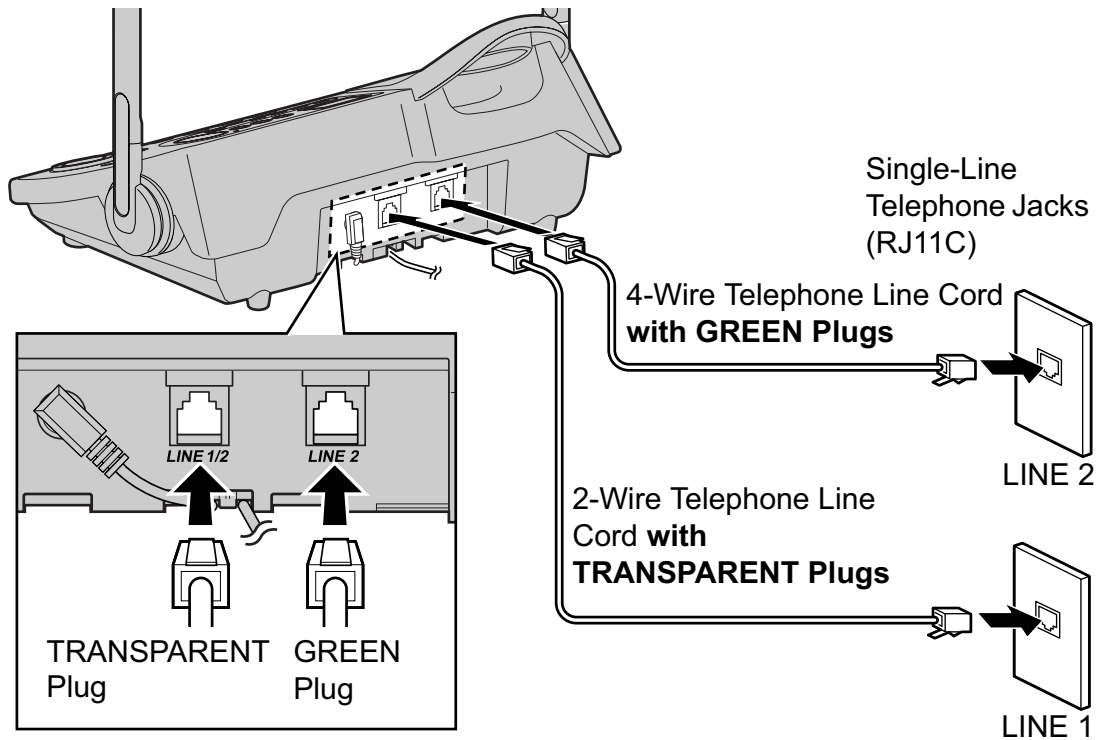

## If you use the unit as a single-line telephone only

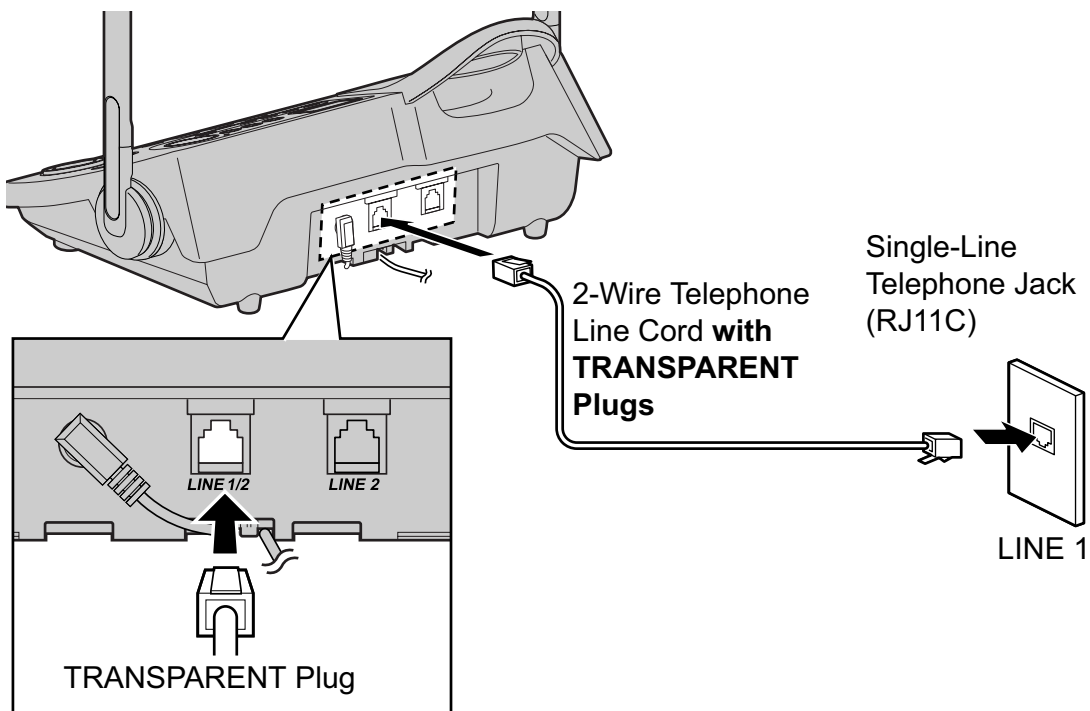

# Installation

## For DSL service users

If the unit is connected to a telephone line with DSL service, you may hear noise from the receiver or speaker during conversations or the unit may not display caller's name and/or phone number properly. We recommend connecting a **noise filter\*** (contact your DSL service provider) to the DSL telephone line between the base unit and the telephone line jack.

### ■ Connecting a 2-line telephone jack

For this connection, please purchase the Panasonic T-adaptor KX-J42. To order, call the accessories telephone number on page 2.

Ex. DSL line is LINE 2.

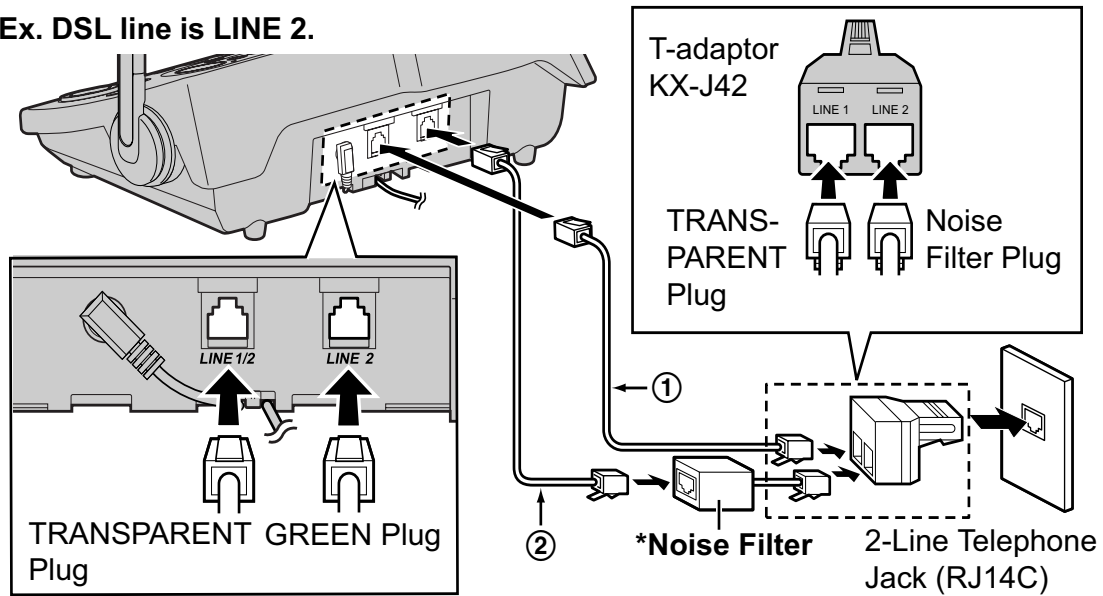

① 2-Wire Telephone Line Cord with **TRANSPARENT** Plugs

② 4-Wire Telephone Line Cord with **GREEN** Plugs

### ■ Connecting 2 single-line telephone jacks

Ex. DSL line is LINE 2.

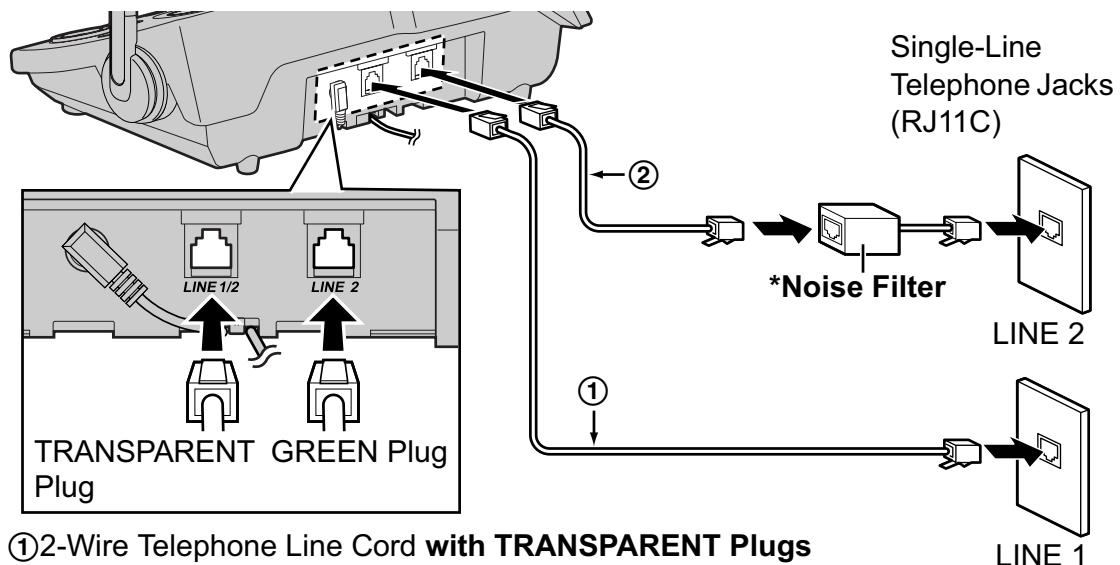

① 2-Wire Telephone Line Cord with **TRANSPARENT** Plugs

② 4-Wire Telephone Line Cord with **GREEN** Plugs

## Installing the Battery in the Handset

Insert the battery (①), and press it down until it snaps into the compartment (②). Close the cover.

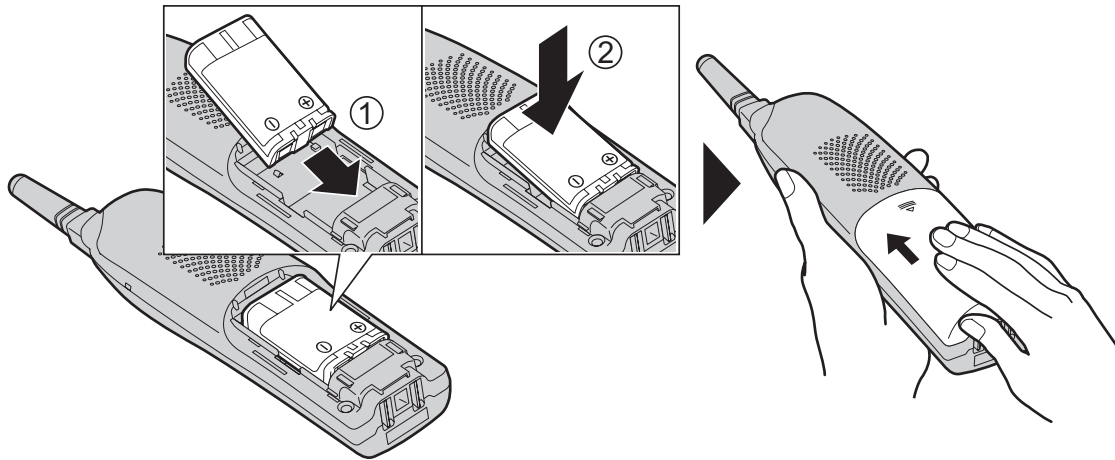

### To replace the battery:

Press the notch on the cover firmly and slide it as indicated by the arrow. Replace the old battery with a new one (p. 16). Close the cover and charge the handset for 6 hours.

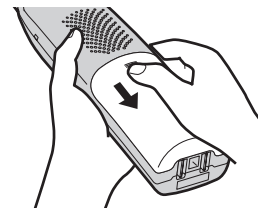

## Battery Charge

Place the handset on the base unit for **6 hours** before initial use.

- The unit beeps once, the CHARGE indicator lights and “Charging” is displayed.
- When the battery is fully charged, “Charge completed” is displayed if there are no new calls in the Caller List.



CHARGE Indicator

## Battery strength

You can confirm the battery strength on the handset display. Battery strength is indicated by the icons shown in the chart to the right.

Display prompt	Battery strength
	Fully charged
	Medium
	Low
(flashing)	Needs to be recharged.
	Discharged



# Installation

## Recharge

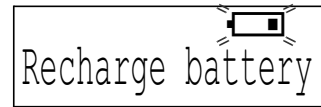

Recharge the battery when:

- “**Recharge battery**” is displayed on the handset,
- “” flashes, or
- the handset beeps intermittently while it is in use.



- The display will continually indicate “**Recharge battery**” and/or “” will flash when the handset battery is charged for less than 15 minutes and the handset is lifted off the base unit.
- If the battery has been discharged, the handset will display “**Charge for 6 HRS**” and “” when you place the handset on the base unit. The handset will not work unless the battery is charged. Continue charging.

### Battery replacement:

If you cleaned the charge contacts and fully charged the battery, but after a few telephone calls, “**Recharge battery**” is displayed and/or “” continues to flash, or “**Charge for 6 HRS**” and “” are displayed, the battery may need to be replaced. Please order a new Panasonic HHR-P104 battery at the telephone number shown on page 2. To replace the battery, see page 15.

A nickel metal hydride battery that is recyclable powers the product you have purchased. Please call 1-800-8-BATTERY for information on how to recycle this battery.



## Battery information

After your Panasonic battery is fully charged, you can expect the following performance:

Operation	Operating time
While in use (TALK)	Up to 5 hours
While not in use (Standby)	Up to 11 days
While using the Clarity Booster feature (p. 35)	Up to 3 hours

- A fully charged battery will give you up to 5 hours of continuous talk time, or keep your handset in Standby mode to receive incoming calls for up to 11 days (if no phone calls are made). Battery power is consumed whenever the handset is off of the base unit, even when the handset is not in use. The longer you leave the handset off of the base unit, the time you can actually talk on the handset will be shortened. Actual battery performance depends on a combination of how often the handset is in TALK mode and how often it is in Standby mode.
- **Clean the charge contacts of the handset and the base unit with a soft, dry cloth once a month. Clean more often if the unit is subject to grease, dust or high humidity.** Otherwise the battery may not charge properly.
- If the battery is fully charged, you do not have to place the handset on the base unit until “**Recharge battery**” is displayed and/or “” flashes. This will maximize the battery life.
- If you want to keep the battery fully charged at all times, place the handset on the base unit when the handset is not used. The battery cannot be overcharged.
- When the Clarity Booster feature is turned on automatically or manually, battery operating time may be shortened (p. 35).



# Programmable Settings

## Programming Guidelines **Handset**

The unit has several programmable functions which can be selected from the function menu on the display (p. 18).



### How to select a function item from the menu

Make sure the handset and base unit are not being used. The handset must be operated near the base unit and while off the base unit.

- 1** Press **[MENU]**.
    - The main menu is displayed (p. 18).
  - 2** Scroll to the desired item by pressing **[▼]** or **[▲]**.

BACK
  - 3** Press the soft key ( ) to select the desired item.
  - 4** If the item has a sub-menu, select the menu item (p. 18). Repeat steps 2 and 3 until the desired item is displayed. If the item has no sub-menu, go to step 5.
  - 5** Select the desired setting by pressing **[▼]** or **[▲]**, then press the soft key ( ).
    - A confirmation tone will be heard and the setting will be saved.

BACK
  - 6** Press **[OFF]** to exit programming mode.
- To go back to the previous menu, press the soft key ( ), or press the soft key ( ) while “--- (Go back) ---” is displayed. If you press this key in the main menu, the unit will exit programming mode.
  - After programming is complete, the display will return to the main menu or the sub-menu depending on which menu the selected item is located. (See the menu table on page 18.)
  - You can exit programming mode at any time by pressing **[OFF]**.
  - If you do not press any buttons for 60 seconds, the unit will exit programming mode.
  - If the unit detects a problem, an error message will be displayed (p. 84) and/or error beeps will sound.

# Programmable Settings

## Function Menu Table **Handset**

You can use the following functions to customize your unit. See the corresponding pages for function details.

- After pressing **[MENU]**, you can also program menu items directly by pressing (**[0]** to **[9]**, **[\*]** and **[#]**) instead of using the soft keys (p. 82, 83).

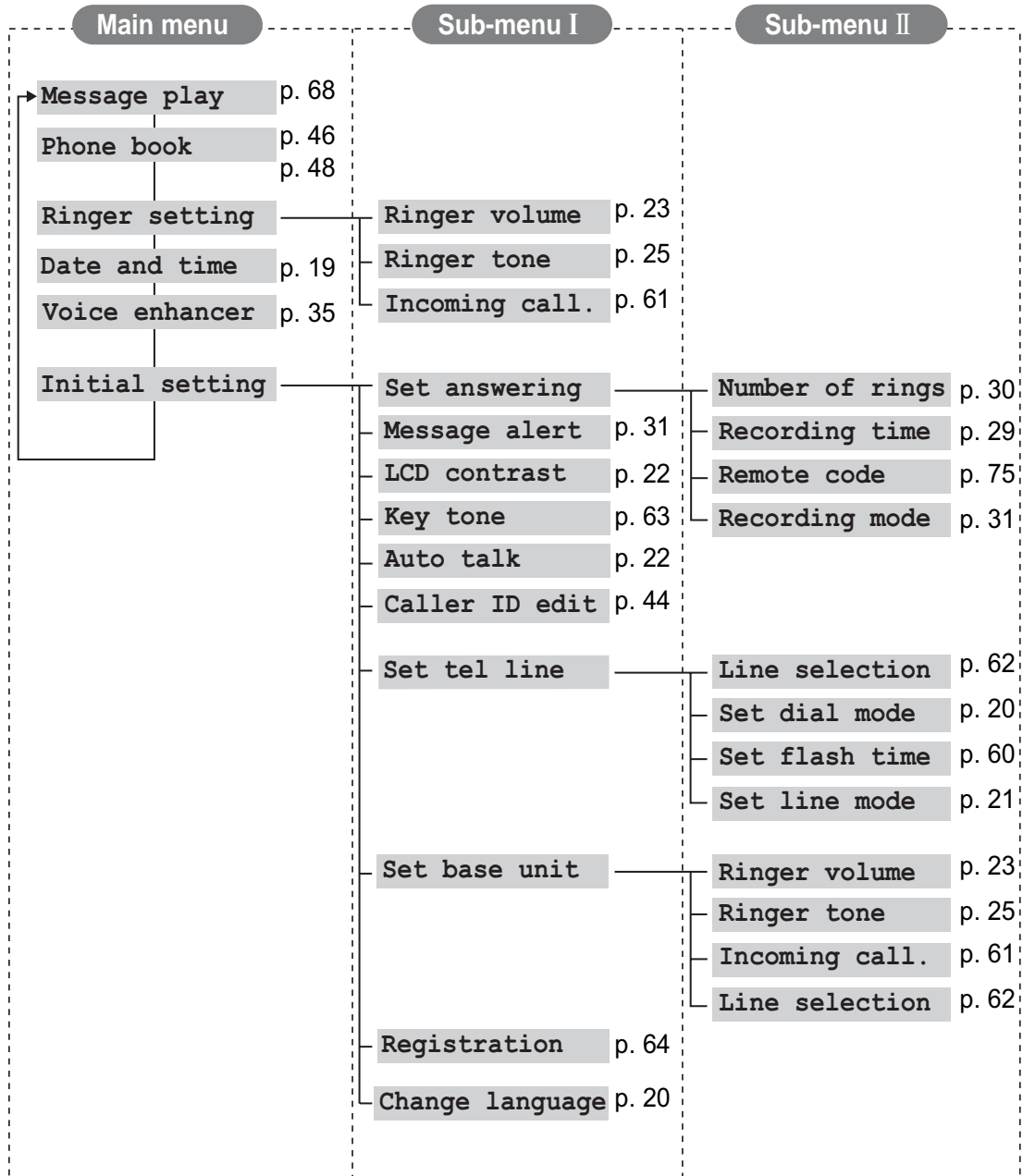

# Programmable Settings

## Date and Time **Handset**

We recommend you set the date and time so that the unit will announce the day and time each message was recorded when you play back messages.

Preparation

**1** Press **[MENU]**.

**2** Scroll to “Date and time” by pressing **[▼]** or **[▲]**, then press the soft key (**SELECT**).

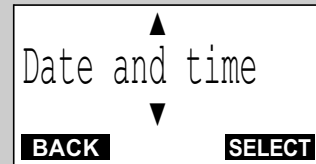

**3** (1) Enter 2 digits each for the month, day and year. (Ex. To set June 15, 2005, enter “06 15 05”.)

(2) Enter 4 digits for the time (hour and minute). (Ex. To set 9:30, enter “0930”.)

- If you enter a wrong number, press the soft key (**◀**) or (**▶**), or press **[▲]** or **[▼]** to move the cursor to the incorrect number. Enter the correct number.

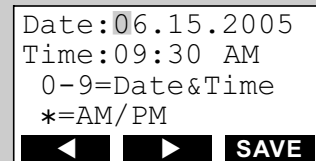
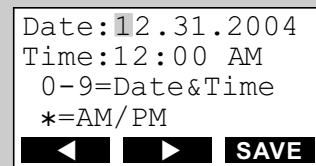

**4** Select “AM” or “PM” by pressing **[\*]**.

**5** Press the soft key (**SAVE**).

- The date and time are set and “Ⓢ” disappears from the base unit display.
- If the handset beeps 3 times, the date and time were not set correctly. Start again from step 3.

**6** Press **[OFF]**.

- When entering the time, you cannot enter numbers greater than 12. **Do not use military time.** (To set 13:00 hours, enter “0100”, and select “PM” in step 4.)

The date and time may be incorrect after a power failure. When “Ⓢ” flashes on the base unit display, set the date and time again.

**To confirm the date and time, repeat steps 1 and 2.**

- The current date and time are displayed. When finished, press **[OFF]**.

### For Caller ID service users (p. 40)

- When a call is received, Caller ID information adjusts the date and time if the time is incorrect.
- Caller ID information will automatically adjust the date and time for daylight saving time.
- If the date and time have not been previously set, Caller ID information will not adjust the date and time.

# Programmable Settings

## Display Language **Handset**

You can select either “English” or “Spanish” as the display language. The factory preset is “English”.

<b>1</b> Press <b>[MENU]</b> .	
<b>2</b> Scroll to “ <b>Initial setting</b> ” by pressing <b>[▼]</b> or <b>[▲]</b> , then press the soft key ( <b>SELECT</b> ).	Initial setting
<b>3</b> Scroll to “ <b>Change language</b> ” by pressing <b>[▼]</b> or <b>[▲]</b> , then press the soft key ( <b>SELECT</b> ).	Change language
<b>4</b> To change from English to Spanish, press the soft key ( <b>ESPAÑOL</b> ). To change from Spanish to English, press the soft key ( <b>ENGLISH</b> ). <ul style="list-style-type: none"><li>• The display changes to the selected language.</li><li>• You can also select the display language by pressing <b>[▼]</b> or <b>[▲]</b>.</li></ul>	Display :English
<b>5</b> When Spanish is selected, press the soft key ( <b>GUARDAR</b> ), then press <b>[OFF]</b> . When English is selected, press the soft key ( <b>SAVE</b> ), then press <b>[OFF]</b> .	

- If you select a language you cannot read, change the display language again using direct commands (p. 83).

## Dialing Mode **Handset**

If you have touch tone service, set the dialing mode to “Tone”. For rotary or pulse service, set to “Pulse”. The factory preset is “Tone”.

<b>1</b> Press <b>[MENU]</b> .	
<b>2</b> Scroll to “ <b>Initial setting</b> ” by pressing <b>[▼]</b> or <b>[▲]</b> , then press the soft key ( <b>SELECT</b> ).	Initial setting
<b>3</b> Scroll to “ <b>Set tel line</b> ” by pressing <b>[▼]</b> or <b>[▲]</b> , then press the soft key ( <b>SELECT</b> ).	Set tel line
<b>4</b> Scroll to “ <b>Set dial mode</b> ” by pressing <b>[▼]</b> or <b>[▲]</b> , then press the soft key ( <b>SELECT</b> ).	Set dial mode
<b>5</b> Select “ <b>Pulse</b> ” or “ <b>Tone</b> ” by pressing <b>[▼]</b> or <b>[▲]</b> .	Set dial mode :Tone
<b>6</b> Press the soft key ( <b>SAVE</b> ), then press <b>[OFF]</b> .	

# Programmable Settings

## Line Mode **Handset**

The line mode for both lines is preset to “B” and generally should not be adjusted. If the line buttons on the base unit do not light properly, or the line status icons (**L1** and **L2**) are not displayed on the handset properly, the line mode selection is incorrect. Set line mode to “A”. Each line has its own setting.

Preparation

<b>1</b> Press <b>[MENU]</b> .	
<b>2</b> Scroll to “Initial setting” by pressing <b>[▼]</b> or <b>[▲]</b> , then press the soft key ( <b>SELECT</b> ).	Initial setting
<b>3</b> Scroll to “Set tel line” by pressing <b>[▼]</b> or <b>[▲]</b> , then press the soft key ( <b>SELECT</b> ).	Set tel line
<b>4</b> Scroll to “Set line mode” by pressing <b>[▼]</b> or <b>[▲]</b> , then press the soft key ( <b>SELECT</b> ).	Set line mode
<b>5</b> Press <b>[▼]</b> ( <b>Line1</b> ) or <b>[▲]</b> ( <b>Line2</b> ) to select the line.	Set line mode ▼=Line1 ▲=Line2
<b>6</b> Select “A” or “B” by pressing <b>[▼]</b> or <b>[▲]</b> .	Set line mode Line1:B
<b>7</b> Press the soft key ( <b>SAVE</b> ) • To select the other line, repeat from step 4.	
<b>8</b> Press <b>[OFF]</b> .	

# Programmable Settings

## Auto Talk **Handset**

The Auto Talk feature allows you to answer calls by simply lifting the handset off the base unit. You do not need to press [↶] or [↷]. The factory preset is OFF.

1 Press [MENU].

2 Scroll to “Initial setting” by pressing [▼] or [▲], then press the soft key (**SELECT**).

Initial setting

3 Scroll to “Auto talk” by pressing [▼] or [▲], then press the soft key (**SELECT**).

Auto talk

4 Select “On” or “Off” by pressing [▼] or [▲].

Auto talk  
:Off

5 Press the soft key (**SAVE**), then press [OFF].

- In order to view Caller ID information after you lift the handset to answer a call, leave the Auto Talk feature turned off.
- If you change the line selection feature from “Auto” to “Line 1” or “Line 2” (p. 62), the Auto Talk feature will function for that line only. If the other line receives a call, the Auto Talk feature will not function.

## LCD Contrast **Handset**

There are 6 levels of LCD contrast. The factory preset is “level 3”.

1 Press [MENU].

2 Scroll to “Initial setting” by pressing [▼] or [▲], then press the soft key (**SELECT**).

Initial setting

3 Scroll to “LCD contrast” by pressing [▼] or [▲], then press the soft key (**SELECT**).

LCD contrast

4 Select the desired contrast by pressing [▼] or [▲].

- The contrast will change.
- The number of steps indicates the contrast level.

Ex. Level 3

LCD contrast  
Low  High

5 Press the soft key (**SAVE**), then press [OFF].

## Ringer Volume

You can set the handset and base unit ringer volumes to high, medium, low, or off for each line. The factory preset for both lines is HIGH.

If the handset or base unit ringer is turned off for both lines, the handset or base unit will ring at the low level for intercom calls, and will not ring for outside calls.

### Handset ringer volume **Handset**

- 1 Press **[MENU]**.
- 2 Scroll to “**Ringer setting**” by pressing **[▼]** or **[▲]**, then press the soft key (**SELECT**).
 

Ringer setting
----------------
- 3 Press the soft key (**SELECT**) at “**Ringer volume**”.
 

Ringer volume
---------------
- 4 Press **[▼]** (**Line1**) or **[▲]** (**Line2**) to select the line.
 

Ringer volume
▼=Line1 ▲=Line2
- 5 Select the desired volume by pressing **[▼]** or **[▲]**.
  - The volume will change and ring.
  - The number of steps indicates the volume level.
  - **To turn the ringer off**, press **[▼]** repeatedly until “**off ?**” is displayed.

To change the ringer tone, press the soft key (**TONE**). Select the ringer tone by pressing **[▼]** or **[▲]**. See “Handset ringer tone” on page 25, step 5.

Ex. High
Ringer volume L1
Low  High
▼▲
<b>BACK TONE SAVE</b>

Ex. Off
Ringer volume L1
Off ?
- 6 Press the soft key (**SAVE**).
  - To select the other line, repeat from step 3.
- 7 Press **[OFF]**.
  - If the handset ringer is turned off for a line, the handset displays “**Ringer off**” and the line number while the handset is not in use. If there are new messages, “**Ringer off**” will not be displayed.
  - You can also adjust each line’s ringer volume while the line is ringing. Press **[▼]** or **[▲]** while the handset is ringing.

# Programmable Settings

---

## Temporary ringer off

While the handset is ringing, you can turn the ringer off temporarily by pressing [OFF]. The handset will ring again the next time a call is received for that line.

## Base unit ringer volume (use either the base unit or the handset)

### Base Unit

Make sure the base unit is not being used.

- 1 Select either line by pressing [LINE SELECT] until "LINE 1" or "LINE 2" is announced.

- The selected line (**LINE 1** or **LINE 2**) is displayed.
- Do not select both lines. You can not set the ringer for both lines at the same time.

Ex. LINE 1 selected.

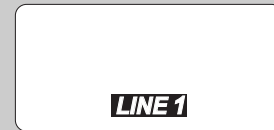

- 2 To set the ringer volume to high (preset), medium, or low, press [▼] or [▲].

- To increase volume, press [▲]. To decrease volume, press [▼].
- To change the ringer tone, press [◀◀] or [▶▶] (p. 26).
- To stop ringing, press [STOP].

To turn the ringer off, press and hold [▼] until 2 beeps sound.

- "L1🔕" or "L2🔕" is displayed.

To turn the ringer on, press [▼] or [▲] in step 2.

- The base unit will ring at the low level for the line.
- You can adjust the base unit ringer volume while the line is ringing. Press [▼] or [▲] while the line is ringing. To turn the ringer off, press and hold [▼] until 2 beeps sound. "L1🔕" or "L2🔕" is displayed.

## Selecting the base unit ringer volume by using the Handset

- 1 Press [MENU].

- 2 Scroll to "Initial setting" by pressing [▼] or [▲], then press the soft key (**SELECT**).

- 3 Scroll to "Set base unit" by pressing [▼] or [▲], then press the soft key (**SELECT**).

- 4 Press the soft key (**SELECT**) at "Ringer volume".

- 5 Follow steps 4 to 7 of "Handset ringer volume" on page 23.

- When selecting the ringer volume, the base unit will ring.



## Ringer Tone

You can set the handset and base unit ringers to use one of 8 ringer patterns for each line. “Tone 1” to “Tone 4” are bell ringer patterns. “Melody 1” to “Melody 4” are melody patterns. LINE 1 is preset to “Tone 1”. LINE 2 is preset to “Tone 2”.

- You cannot change the ringer tone for intercom calls.
- If you subscribe to a Distinctive Ring Service (such as IDENTA-RING) from your telephone company with 2 or 3 consecutive rings, select a bell ringer pattern (Tone 1 to 4). If you select a melody pattern, you will not be able to distinguish lines by their ringers.
- If you select one of the melody ringer patterns, the ringer will continue to sound for several seconds if:
  - the caller hangs up before you answer the call, or
  - another person answers the call using another phone connected on the same line.
- If LINE 1 and LINE 2 have different ringer patterns and both lines receive calls simultaneously, both ringers will ring alternately.

### Handset ringer tone **Handset**

**1** Press **[MENU]**.

**2** Scroll to “**Ringer setting**” by pressing **[▼]** or **[▲]**, then press the soft key (**SELECT**).

Ringer setting

**3** Scroll to “**Ringer tone**” by pressing **[▼]** or **[▲]**, then press the soft key (**SELECT**).

Ringer tone

**4** Press **[▼]** (**Line1**) or **[▲]** (**Line2**) to select the line.

Ringer tone  
▼=Line1 ▲=Line2

**5** Select the desired ringer tone by pressing **[▼]** or **[▲]**.

- The handset will ring and the ringer tone will change. If the ringer volume has been turned off, the handset will not ring.

Ringer tone L1  
1:Tone 1  
▼▲  
**BACK** **VOLUME** **SAVE**

- You can also select the ringer tone by pressing **[1]** to **[8]**.  
**[1]** to **[4]**: Bell ringer patterns  
**[5]** to **[8]**: Melody patterns

To adjust the ringer volume, press the soft key (**VOLUME**). Adjust the ringer volume by pressing **[▼]** or **[▲]**. See “Handset ringer volume” on page 23, step 5.

**6** Press the soft key (**SAVE**).

- To select the other line, repeat from step 3.

**7** Press **[OFF]**.

# Programmable Settings

---

## Base unit ringer tone (use either the base unit or the handset)

### Base Unit

Make sure the base unit is not being used.

- 1 Select either line by pressing **[LINE SELECT]** until “LINE 1” or “LINE 2” is announced.
    - The selected line (**LINE 1** or **LINE 2**) is displayed.
    - Do not select both lines. You cannot set the ringer for both lines at the same time.
- Ex. LINE 2 selected.

- 2 Press **[◀◀]** or **[▶▶]** repeatedly to select the desired tone.
    - Each time you press **[◀◀]** or **[▶▶]**, another ringer tone will be heard and selected.
    - If the ringer volume has been turned off, the base unit will not ring. Press **[▼]** or **[▲]** to turn the ringer on.
    - To stop ringing, press **[STOP]**.
    - You can also select the ringer tone by pressing **[1]** to **[8]**.
      - [1]** to **[4]**: Bell ringer patterns
      - [5]** to **[8]**: Melody patterns
    - To change the ringer volume, press **[▲]** or **[▼]** (p. 24, step 2).
- 

### Selecting the base unit ringer tone by using the Handset

- 1 Press **[MENU]**.
  - 2 Scroll to “Initial setting” by pressing **[▼]** or **[▲]**, then press the soft key (**SELECT**).
  - 3 Scroll to “Set base unit” by pressing **[▼]** or **[▲]**, then press the soft key (**SELECT**).
  - 4 Scroll to “Ringer tone” by pressing **[▲]** or **[▼]**, then press the soft key (**SELECT**).
  - 5 Follow steps 4 to 7 of “Handset ringer tone” on page 25.
    - When selecting the ringer tone, the base unit will ring. If the base unit ringer volume has been turned off (p. 24), the base unit will not ring.
-

# Preparing the Answering System

## Greeting Message **Base Unit**

You can record a personal greeting message of **up to 2 minutes** for each line or a common greeting message for both lines. If you do not record your own message, one of 2 pre-recorded greetings will be played for callers (p. 28).

The total recording time of all messages (greeting, incoming and memo) is **about 60 minutes**. We recommend you record **a brief greeting message** in order to leave more time for recording new messages.

- You can use the enhanced recording mode for clearer sound, if necessary (p. 31).

## To record a greeting message

### Greeting message samples

“Hello, this is (your name and/or number). Sorry, I cannot take your call. Please leave a message after the beep. Thank you.”

- 1 To record a common greeting for both lines, press **[LINE SELECT]** repeatedly until “LINE 1 and LINE 2” is announced.

- “**LINE 1 LINE 2**” is displayed.

To record a greeting for either line individually, press **[LINE SELECT]** repeatedly until “LINE 1” or “LINE 2” is announced.

- “**LINE 1**” or “**LINE 2**” is displayed.

- 2 Press **[GREETING REC]**.

- “To record greeting, press RECORD again” is heard.

- 3 Within 10 seconds, press **[GREETING REC]** again to record your greeting.

- 4 After the long beep, talk clearly, about 20 cm (8 inches) away from the **MIC** (microphone).

- The elapsed recording time is displayed.
- If you record for over 2 minutes, the unit will stop recording.

- 5 When finished, press **[GREETING REC]** or **[STOP]**.

- To change the greeting, start again from step 1.

To review the greeting, press **[GREETING CHECK]** when finished (p. 28).

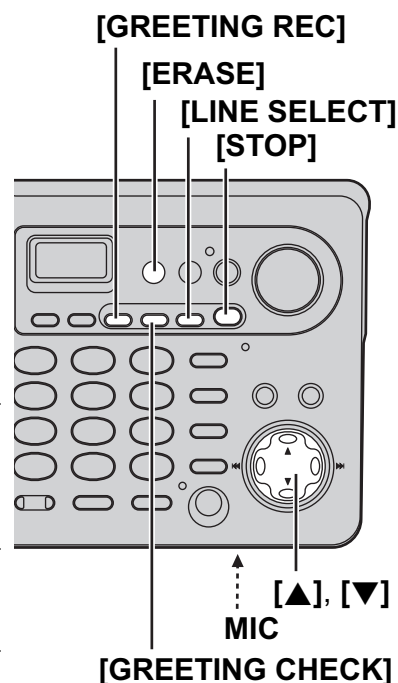

# Preparing the Answering System

---

- If “E” is displayed, 6 beeps sound and “Your greeting was not recorded. Record your greeting again.” is announced, start again from step 1.

## To review the greeting

1. Select the line(s) by pressing **[LINE SELECT]**.
2. Press **[GREETING CHECK]**.
  - When both lines are selected and they have separate greetings, the LINE 1 greeting will be played first.

**To adjust the speaker volume**, press **[▼]** or **[▲]** during playback.

- 9 levels (0–8) are available while using the Answering System. The level is displayed on the base unit.

## To erase the greeting

1. Select the line(s) by pressing **[LINE SELECT]**.
2. Press **[GREETING CHECK]**, then press **[ERASE]** while the recorded message is being played.
  - The unit will answer calls for the line using a pre-recorded greeting (see below).

## Pre-recorded greeting

If you do not record a greeting (p. 27), one of 2 greetings will be played when a call is received, depending on the caller’s recording time (p. 29).

**To review the pre-recorded greeting**, select the line(s) by pressing **[LINE SELECT]**, then press **[GREETING CHECK]**.

- A pre-recorded greeting will be played as follows:
  - When the recording time is set to “1 minute”, “2 minutes” or “3 minutes”:  
“Hello, we are not available now. Please leave your name and phone number after the beep. We will return your call.”
  - If recording time runs out, the unit will automatically switch to the “Greeting only” mode (see below), and no new messages will be recorded.
  - When the recording time is set to “Greeting only”:  
“Hello, we are not available now. Please call again. Thank you for your call.”

### **Flash Memory Message Backup (Message storage)**

Messages stored in memory will not be affected by power failures. All messages are saved until you erase them.

# Preparing the Answering System

## Caller's Recording Time **Handset**

You can select "1 minute", "2 minutes", "3 minutes" or "Greeting only" for the caller's recording time. Each line has its own setting. The factory preset for both lines is "3 minutes".

<b>1</b> Press <b>[MENU]</b> .	
<b>2</b> Scroll to " <b>Initial setting</b> " by pressing <b>[▼]</b> or <b>[▲]</b> , then press the soft key ( <b>SELECT</b> ).	Initial setting
<b>3</b> Press the soft key ( <b>SELECT</b> ) at " <b>Set answering</b> ".	Set answering
<b>4</b> Scroll to " <b>Recording time</b> " by pressing <b>[▼]</b> or <b>[▲]</b> , then press the soft key ( <b>SELECT</b> ).	Recording time
<b>5</b> Press <b>[▼]</b> ( <b>Line1</b> ) or <b>[▲]</b> ( <b>Line2</b> ) to select the line.	Recording time ▼=Line1 ▲=Line2
<b>6</b> Select the recording time by pressing <b>[▼]</b> or <b>[▲]</b> . • You can also select the recording time by pressing <b>[1]</b> , <b>[2]</b> , <b>[3]</b> , or <b>[0]</b> (Greeting only).	Recording time L1:3min
<b>7</b> Press the soft key ( <b>SAVE</b> ). • To select the other line, repeat from step 4.	
<b>8</b> Press <b>[OFF]</b> .	

If you select "**Greeting only**" for the line(s), the unit will answer a call with the greeting message, and then hang up. The unit will not record any incoming messages for the line(s). When you turn the Answering System on, the base unit will display "☎" and the line(s) (**LINE 1** and/or **LINE 2**) for a few seconds.

# Preparing the Answering System

## Number of Rings **Handset**

You can select the number of times the unit rings before the Answering System answers a call, from “2” to “7” or “Toll saver”\*. Each line has its own setting. The factory preset for both lines is “4”.

<b>1</b> Press <b>[MENU]</b> .	
<b>2</b> Scroll to “ <b>Initial setting</b> ” by pressing <b>[▼]</b> or <b>[▲]</b> , then press the soft key ( <b>SELECT</b> ).	Initial setting
<b>3</b> Press the soft key ( <b>SELECT</b> ) at “ <b>Set answering</b> ”.	Set answering
<b>4</b> Press the soft key ( <b>SELECT</b> ) at “ <b>Number of rings</b> ”.	Number of rings
<b>5</b> Press <b>[▼]</b> ( <b>Line1</b> ) or <b>[▲]</b> ( <b>Line2</b> ) to select the line.	Number of rings ▼=Line1 ▲=Line2
<b>6</b> Select the number of rings by pressing <b>[▼]</b> or <b>[▲]</b> . <ul style="list-style-type: none"><li>• You can also select the number of rings by pressing <b>[0]</b> (Toll saver*), or <b>[2]</b> to <b>[7]</b>.</li></ul>	Number of rings Line1:4
<b>7</b> Press the soft key ( <b>SAVE</b> ). <ul style="list-style-type: none"><li>• To select the other line, repeat from step 4.</li></ul>	
<b>8</b> Press <b>[OFF]</b> .	

### \*Toll saver

When you call a line to which “Toll saver” has been set, from a remote location, the number of rings will tell you if there are any new messages. If the unit answers on the 2nd ring, there is at least 1 new message. If the unit answers on the 4th ring, there are no new messages. To save the toll charges for the call, hang up immediately when you hear the 3rd ring. The 3rd ring indicates that there are no new messages.

# Preparing the Answering System

## Recording Mode **Handset**

2 recording modes are available. The factory preset is “Standard recording (60 min)”, which provides more recording time (60 min) and standard sound quality. “Enhanced recording (30 min)” provides less recording time (30 min) but clearer sound quality.

<b>1</b> Press <b>[MENU]</b> .	
<b>2</b> Scroll to “ <b>Initial setting</b> ” by pressing <b>[▼]</b> or <b>[▲]</b> , then press the soft key ( <b>SELECT</b> ).	Initial setting
<b>3</b> Press the soft key ( <b>SELECT</b> ) at “ <b>Set answering</b> ”.	Set answering
<b>4</b> Scroll to “ <b>Recording mode</b> ” by pressing <b>[▼]</b> or <b>[▲]</b> , then press the soft key ( <b>SELECT</b> ).	Recording mode
<b>5</b> Select the recording mode by pressing <b>[▼]</b> or <b>[▲]</b> . • You can also select the recording mode by pressing <b>[1]</b> (Standard) or <b>[2]</b> (Enhanced).	Recording mode :Standard recording 60min
<b>6</b> Press the soft key ( <b>SAVE</b> ), then press <b>[OFF]</b> .	

## Message Alert **Handset**

You can select whether or not the Ringer/Message Alert indicator on the handset will flash slowly when new messages have been recorded (p. 67). The factory preset is OFF.

<b>1</b> Press <b>[MENU]</b> .	
<b>2</b> Scroll to “ <b>Initial setting</b> ” by pressing <b>[▼]</b> or <b>[▲]</b> , then press the soft key ( <b>SELECT</b> ).	Initial setting
<b>3</b> Scroll to “ <b>Message alert</b> ” by pressing <b>[▼]</b> or <b>[▲]</b> , then press the soft key ( <b>SELECT</b> ).	Message alert
<b>4</b> Select “ <b>On</b> ” or “ <b>Off</b> ” by pressing <b>[▼]</b> or <b>[▲]</b> .	Message alert :Off
<b>5</b> Press the soft key ( <b>SAVE</b> ), then press <b>[OFF]</b> .	

- The Ringer/Message Alert indicator will not flash for new messages while the handset is in use.
- The Ringer/Message Alert indicator acts as a ringer indicator and as a message alert indicator. This indicator will flash rapidly when a call is received whether this feature is on or off.
- Battery operating time may be shortened when using this feature (p. 16).

# Making Calls

## System capabilities

2 outside calls can be handled simultaneously on separate telephone lines by the handset and the base unit.

## Using the Handset **Handset**

### 1 Press [].

- A free line is automatically selected and the line is displayed. (To change the line selection, see page 62.)
- You can select a line by pressing a line soft key (**LINE1**) or (**LINE2**), instead of pressing [].
- “**Talk**” is displayed.

### 2 Dial a phone number.

- The dialed number is displayed.
- After a few seconds, the display will show the length of the call.

### 3 To hang up, press [**OFF**] or place the handset on the base unit.

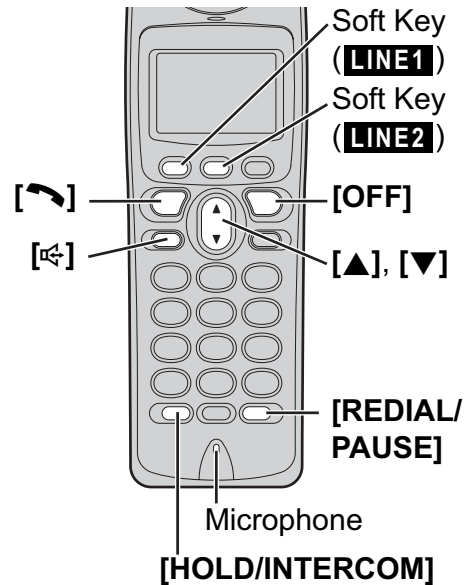

- The line status icons (**L1** and **L2**) show the status of each line (p. 9).
- While using the handset, the IN USE indicator lights on the base unit.

## To have a hands-free phone conversation

### 1 Press [].

- A free line is automatically selected and the line is displayed. (To change the line selection, see page 62.)
- “**SP-phone**” is displayed.

### 2 Dial a phone number.

- The dialed number is displayed.
- After a few seconds, the display will show the length of the call.

### 3 When the other party answers, talk into the microphone.

### 4 To hang up, press [**OFF**] or place the handset on the base unit.



## Hands-free Digital Duplex Speakerphone

For best performance, please note the following:

- Talk alternately with the other party in a quiet room.
- If you or the other party has difficulty hearing, press [▼] to decrease the speaker volume.
- While talking using [↶], or a line soft key (**LINE1**) or (**LINE2**), you can switch to a hands-free phone conversation by pressing [↷]. To switch back to the receiver, press [↶].

## To dial after confirming the entered number

1. Enter a phone number.



- If you misdial, press the soft key (**CLEAR**). Enter the correct phone number.
- If a pause is required when dialing, press **[REDIAL/PAUSE]** where needed (p. 58).
- To cancel, press **[OFF]**.

2. Press [↶], [↷], or a line soft key (**LINE1**) or (**LINE2**).

3. To hang up, press **[OFF]** or place the handset on the base unit.

## To adjust the receiver/speaker volume during a conversation

There are 3 volume levels for the receiver and 6 volume levels for the speaker.

To increase volume, press [▲].

Ex. Receiver volume: High  
Speaker volume: Level 6

To decrease volume, press [▼].

- The display shows the current volume setting.
- If you try to increase/decrease volume when it is at the maximum/minimum level, the handset will beep 3 times.



## To redial the last number dialed

1. Press [↶], [↷], or a line soft key (**LINE1**) or (**LINE2**).

2. Press **[REDIAL/PAUSE]**.

# Making Calls

---

## To redial using the redial list (Memory Redial)

The last 5 phone numbers dialed are stored in the redial list.

1. Press **[REDIAL/PAUSE]**.
  - The last number dialed is displayed.
2. Scroll to the desired number by pressing **[▼]** or **[▲]**.
  - You can also scroll down through the list by pressing **[REDIAL/PAUSE]**.
  - To exit the list, press **[OFF]**.
3. Press **[↶]**, **[↷]**, or a line soft key (**LINE1**) or (**LINE2**).
  - **To erase an item**, scroll to the item then press the soft key (**ERASE**).
  - If “No items stored” is displayed, the list is empty.

## To put a call on hold

1. Press **[HOLD/INTERCOM]** during a conversation.
  - “**LINE1**” or “**LINE2**” flashes with the line status icon (**L1** or **L2**).
  - “Press extension# to transfer” is displayed.
  - To transfer the call to the base unit, see page 54; to transfer to the Answering System, see page 73.
2. Press **[HOLD/INTERCOM]** again.
  - “Hold” and the line are displayed.

Ex. LINE1 on hold.



**To return to the call**, press the line soft key (**LINE1**) or (**LINE2**) that is flashing.

- The base unit user can also take the call by pressing the line button that is flashing.
- If another phone is connected on the same line (p. 11), you can also take the call by lifting its handset.
- If a call is kept on hold for 6 minutes, an alarm tone will start to sound and the Ringer/Message Alert indicator will start to flash rapidly. After 4 additional minutes on hold, the call will be disconnected.

## Backlit LCD display/Lighted handset keypad

The handset display and dialing buttons will light for a few seconds after pressing a button or lifting the handset off the base unit. They will also light when an intercom/ outside call is being received.

### Clarity Booster

This feature can improve sound clarity when the handset is used in an area where there may be interference. During an outside call, this feature will be turned on automatically when necessary. This feature will turn off when you hang up, put a call on hold, or make a conference call. It will not turn off automatically during a call. You can also turn this feature on or off manually.

1. Press **[MENU]** during an outside call.
2. Press **[3]** to select “**3=Booster on**” or “**3=Booster off**”.

- You can ai72.8371 Tf0 1 0 0 1o1.9( Tf0.3319 I/F1 1 Tf01964 0 TD0.3= 1 0 023can aiTc0 TwBo)6(os

# Making Calls

- When the handset is not in use, you can also turn this feature on or off by performing the following steps:
  1. Press **[MENU]** while the handset is not in use.
  2. Scroll to “voice enhancer” by pressing **[▼]** or **[▲]**, then press the soft key (**SELECT**).
  3. Select “On” or “Off” by pressing **[▼]** or **[▲]**.
  4. Press the soft key (**SAVE**), then press **[OFF]**.

## Using the Base Unit **Base Unit**

### 1 Press **[SP-PHONE]**.

- The SP-PHONE indicator lights.
- A free line is automatically selected and the line button lights. (To change the line selection, see page 63.)
- You can select a line by pressing a line button that does not light, instead of pressing **[SP-PHONE]**.

### 2 Dial a phone number.

- If you misdial, press **[SP-PHONE]** and start again from step 1.

### 3 When the other party answers, talk into the **MIC** (microphone).

### 4 To hang up, press **[SP-PHONE]**.

- The SP-PHONE indicator and line button lights go out.

- To switch to the handset while using the base unit speakerphone:
  - If the handset is off the base unit, press the line soft key (**LINE1**) or (**LINE2**) on the handset, then press **[SP-PHONE]** on the base unit.
  - If the handset is on the base unit, just lift up.
- The line buttons show the status of each line (p. 37).

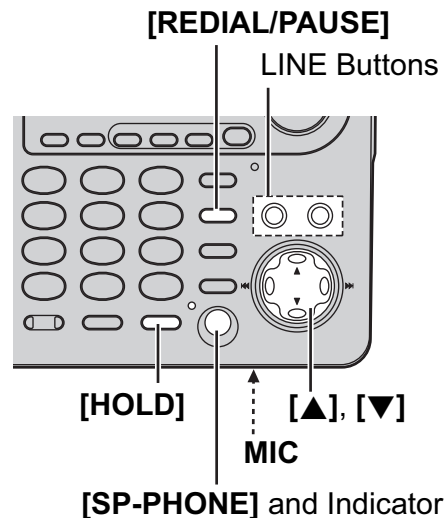

### **Hands-free Digital Duplex Speakerphone**

For best performance, please note the following:

- Talk alternately with the other party in a quiet room.
- If you or the other party has difficulty hearing, press **[▼]** to decrease the speaker volume.

## To adjust the speaker volume during a conversation

To increase volume, press **[▲]**. To decrease volume, press **[▼]**.

- There are 8 volume levels. If you try to increase/decrease volume when it is at the maximum/minimum level, the base unit beeps 3 times. The level is displayed on the base unit.

### To redial the last number dialed

Press [SP-PHONE] or a line button, then press [REDIAL/PAUSE].

### To put a call on hold

Press [HOLD] during a conversation.

- The line button flashes.

To return to the call, press the line button that is flashing.

- The handset users can also take the call by pressing the line soft key (**LINE1**) or (**LINE2**).
- If another phone is connected on the same line (p. 11), you can also take the call by lifting its handset.
- If a call is kept on hold for 6 minutes, an alarm tone will start to sound. After 4 additional minutes on hold the call will be disconnected.

### How the line buttons indicate the line status

The line buttons indicate the status of each line as follows.

Light off	The line is free.
Light on	The line is being used.
Flashing	A call is on hold on the handset or base unit, or the Answering System is answering a call (p. 65).
Flashing rapidly	A call is being received.

# Answering Calls

When a call is received, the unit rings, “**Incoming call**” and the called line are displayed, and the Ringer/Message Alert indicator on the handset and the line button on the base unit flash rapidly.

2 calls can be handled simultaneously on separate telephone lines by the handset and the base unit.

## Handset

**1** Press [] or [].

- The called line is automatically selected. (To change the line selection, see page 62.)
- You can also answer a call by pressing the called line soft key (**LINE1**) or (**LINE2**).
- You can also answer a call by pressing any button except [**▼**], [**▲**] or [**OFF**].

**2** To hang up, press [**OFF**] or place the handset on the base unit.

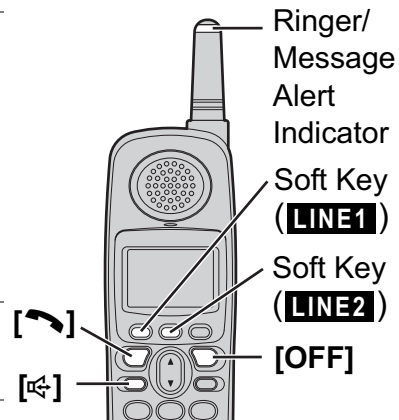

## Auto Talk

If the Auto Talk feature is turned on (p. 22), you can answer a call by simply lifting the handset off the base unit.

## Temporary ringer off

While the handset is ringing, you can turn the ringer off temporarily by pressing [**OFF**]. The handset will ring again the next time a call is received on that line.

## Base Unit

**1** Press [**SP-PHONE**].

- The called line is automatically selected. (To change the line selection, see page 63.)
- You can also answer a call by pressing the called line button.

**2** Talk into the **MIC**.

**3** To hang up, press [**SP-PHONE**].

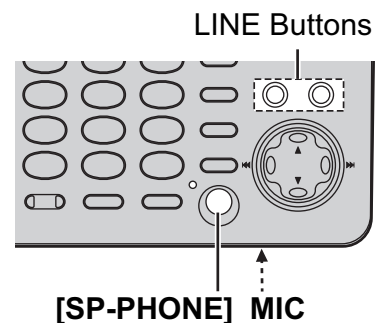

- To transfer the call to another unit, see page 54.
- To transfer the call to the Answering System to allow the caller to leave a message, see page 73.
- If the ringer volume is turned off for the called line, the unit will not ring for the line (p. 23, 24).

# Using the Other Line During a Conversation

When a call is being received on the other line during a conversation, you will hear **2 tones**. The line button will flash rapidly on the base unit.

You can answer the second call while holding the first call. You can also make a call without terminating the first call.

You can turn off the **2 tones** (Incoming call tone). See page 61.

If you subscribe to Caller ID, the second caller's information will be displayed when a call is being received on the other line (p. 40).

## Handset

### 1 Ex. If you are using LINE 1

Press **[HOLD/INTERCOM]** 2 times to put the first call (LINE 1) on hold.

- "**LINE1**" flashes on the display.

Ex. Receiving a second call

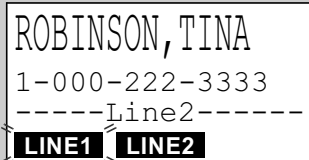

ROBINSON, TINA  
1-000-222-3333  
-----Line2-----  
**LINE1** **LINE2**

### 2 Press the other line soft key (**LINE2**) to make or answer a second call.

- To hold the second call, press **[HOLD/INTERCOM]** 2 times.



Talk Line2  
Hold Line1  
**LINE1** **CONF** **MUTE**

### 3 To return to the first call (LINE 1), press the line soft key (**LINE1**) for the first call (LINE 1).

- The second call is terminated.

## Base Unit

### 1 Ex. If you are using LINE 1

Press **[HOLD]** to put the first call (LINE 1) on hold.

- The LINE 1 button flashes.

### 2 Press the other line button (LINE 2) to make or answer a second call.

- The LINE 2 button lights.
- To hold the second call, press **[HOLD]**.

### 3 To return to the first call (LINE 1), press the line button for the first call (LINE 1).

- The second call is terminated.

# Caller ID Service

This unit is compatible with Caller ID services offered by your telephone company. If you subscribe to Caller ID, caller names and phone numbers will be displayed and recorded in the Caller List.

## How Caller ID information is displayed

When a call comes in, the unit will ring and Caller ID information will be received. The handset display will show the caller's information\* and the called line.

- After you answer the call, the display will show the length of the call.

Example

ROBINSON, TINA
1-555-222-3333
-----Line1-----

### \*Personalized Name Display

If you receive a call from one of the phone numbers stored in the phone book, the handset will show the caller's name stored in the phone book instead of incoming caller's name.

- Numbers and names programmed in the phone book will be displayed in the Caller List as programmed regardless of Auto Edit feature.
- If the unit does not receive Caller ID information, one of the following will be displayed:

Display	Meaning
Out of area	The caller dialed from an area which does not provide Caller ID service.
Private caller	The caller requested not to send his/her information.
Long distance	The caller made a long distance call.

- Depending on radio communications with the base unit, the handset may not display Caller ID information immediately after the first ring.
- If your unit is connected to a PBX which does not support Caller ID, you cannot access Caller ID service.
- Name display service may not be available in some areas. For further information, please contact your telephone company.
- If you subscribe to both Caller ID and Call Waiting with Caller ID service (CWID), when a second call is received on the same line while talking, a call waiting tone will be heard and the second caller's information will be displayed (p. 59). Contact your telephone company for details about availability in your area, and to verify that CWID service is activated on your telephone line.
- If both lines receive calls at the same time, each caller's information will be displayed alternately.



# Using the Caller List

The unit can record information up to 50 different callers for both lines combined and store this information in the Caller List. Caller information is sorted by the most recent call to the oldest. When the 51<sup>st</sup> call is received, the information from the 1<sup>st</sup> call is deleted.

The unit will also tell you how many calls you missed while you were out or unavailable to answer the phone.



The handset display will show the number of calls you missed.

Press [▼] or [▲] to review calls logged in the Caller List.

- You can also press the soft key (**SEARCH**), then press the soft key (**CID**=Caller Identification) to enter the Caller List.
- After viewing the missed call entries, "missed calls" will disappear from the display.

## Viewing the Caller List **Handset**

**1** Press [▼] or [▲] to enter the Caller List.

Ex. 10 calls missed.

A simulated handset display showing the text "Caller list" on the first line, "10 missed calls" on the second line, and "▼▲=Scroll list" on the third line.

**2** To search from the most recent call, press [▼].  
To search from the oldest call, press [▲].

- The caller's name and number, the called line (**1** or **2**) and the time and date of the call are displayed.

Example

A simulated handset display showing caller information: "SMITH, JACK" on the first line, "1-555-333-4444 **1**" on the second line, and "3:10P JUN.10" on the third line.

**3** Press [OFF] to exit the list.

- If there is no name information for a caller and you do not store the name and phone number in the phone book, the display will only show the phone number.
- If you do not press any buttons for 60 seconds, the unit will exit the Caller List.

# Using the Caller List

---

## What “1” and “2” mean

Indication of which line the caller information was received from.

SMITH, JACK 1-555-333-4444 <b>1</b> 3:10P JUN.10
--

## What “✓” means

“✓” indicates you have already viewed this calling information or answered the call. If the same caller calls again, the call entry with the “✓” will be replaced with the new call entry.

SMITH, JACK 1-555-333-4444 <b>1</b> 3:10P JUN.10 ✓
--

## If a caller calls more than once

The number of times the same caller called is displayed (“x2” to “x9”). The date and time of the most recent call will be recorded. After viewing a caller’s information, “x2” to “x9” will be replaced with “✓”.

Ex. Called 3 times.

TURNER, CINDY 1-555-456-7890 <b>2</b> 11:20A JAN.12 x3
--

## Calling Back from the Caller List **Handset**

---

1 Press [▼] or [▲] to enter the Caller List.

---

2 Scroll to the desired caller by pressing [▼] or [▲].

---

3 Press [↶] or [↷].

OR

Press the soft key (**CALL**), then press a line soft key (**LINE1**) or (**LINE2**).

- If the line selection is “Auto” (p. 62) and you press [↶] or [↷], the indicated line will be selected. If the indicated line is already being used, press the soft key (**CALL**), then select the other line by pressing the line soft key (**LINE1**) or (**LINE2**).
  - The phone number is dialed.
- 

- In some cases, you may have to edit the number before dialing (p. 43). (Ex. You may have to delete “1” and the area code.)
- If a phone number is not displayed in the caller information, you cannot call that caller back from the Caller List.

## Editing the Caller's Phone Number **Handset**

You can edit a phone number in the Caller List by removing its area code and/or the long distance code "1".

Once you call back an edited number, this unit can automatically edit incoming phone numbers from the same area code in the Caller List and each time you receive a call (**Caller ID Number Auto Edit**, p. 44).

You can also edit a phone number to store it in the phone book (p. 45).

**1** Press [▼] or [▲] to enter the Caller List.

**2** Scroll to the desired caller by pressing [▼] or [▲].

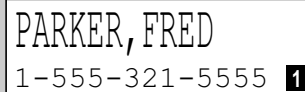

PARKER, FRED  
1-555-321-5555 1

**3** Press the soft key (**CALL**).

**4** Press the soft key (**EDIT**) repeatedly until the number is shown in the desired format.

- Each time you press the soft key (**EDIT**), the number is rearranged into one of 3 patterns.

- Ⓐ Phone no.
- Ⓑ Area code – Phone no.
- Ⓒ 1– Area code – Phone no.

- The order in which patterns Ⓐ–Ⓒ are displayed depends on how the telephone number is displayed in step 2.

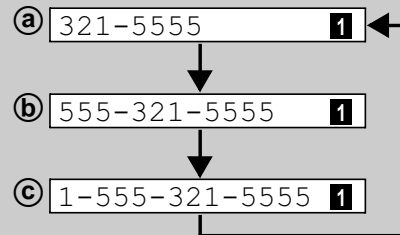

**5** To call the edited number, press [↶], [↷], or a line soft key (**LINE1**) or (**LINE2**).

- If the line selection is "Auto" (p. 62), the indicated line will be selected by pressing [↶] or [↷]. If the indicated line is already being used, select the other line by pressing the line soft key (**LINE1**) or (**LINE2**).
- If Caller ID Number Auto Edit feature is turned on (factory preset is on), phone numbers with the same area code as the number you edited will now be updated in the Caller List and each time you receive a call.
- You can press [OFF] immediately after pressing [↶], [↷], or the line soft key (**LINE1**) or (**LINE2**) if you wish to activate the Auto Edit feature without actually dialing the number you just edited.

# Using the Caller List

## Caller ID Number Auto Edit **Handset**

Once you call back an edited number (p. 43), this unit can automatically edit incoming phone numbers from the same area code in the Caller List and each time you receive a call. For example, it can ignore the area code of calls originating from your area code, so that you can call these numbers from the Caller List without dialing the area code.

**To activate this feature**, you must edit a caller's phone number in the Caller List (p. 43) by selecting pattern **(a)**, **(b)**, or **(c)**, then make a call to that number. Calls from numbers in that area code will be edited automatically. The unit can remember up to 4 area codes to be edited according to patterns **(a)** and **(b)**.

When the 5th area code is edited, the oldest area code is reset to pattern **(c)**. Phone numbers from the 4 most recently edited area codes will be automatically edited.

You can turn this feature on or off using the handset. The factory preset is ON.

### To turn on or off Caller ID Number Auto Edit feature

**1** Press **[MENU]**.

**2** Scroll to "Initial setting" by pressing **[▼]** or **[▲]**, then press the soft key (**SELECT**).

Initial setting

**3** Scroll to "Caller ID edit" by pressing **[▼]** or **[▲]**, then press the soft key (**SELECT**).

Caller ID edit

**4** Select "Off" or "On" by pressing **[▼]** or **[▲]**.

Auto edit  
:On

**5** Press the soft key (**SAVE**), then press **[OFF]**.

- If you fail to reach your destination when making a call, the phone number you dialed might have an incorrect pattern. Edit the phone number with another pattern (p. 43).
- When this feature is turned off, the unit will still be able to display Caller ID, but incoming Caller ID numbers will not be automatically edited.
- If you move to another area you may need to turn this feature off to erase the previously edited area codes. To use this feature again, turn it on and reprogram the area codes you want to be edited once again.

## Storing Caller Information in the Phone Book **Handset**

Caller names and phone numbers that are in the Caller List can be stored in the phone book.

- 1 Press [▼] or [▲] to enter the Caller List.
  - 2 Scroll to the desired caller by pressing [▼] or [▲].
  - 3 Press the soft key (**SAVE**).
    - To edit the phone number, press the soft key (**EDIT**) repeatedly until the number is shown in the desired format (p. 43, step 4).
  - 4 Press the soft key (**SAVE**) again.
    - If there is no name information for the caller, “Enter name” will be displayed.
      - You can enter a name by performing the following steps:
        - (1) enter the name (p. 47),
        - (2) press [▼], and
        - (3) press the soft key (**SAVE**).
      - If a name is not required, press [▼], then press the soft key (**SAVE**).
    - To continue storing other items, repeat from step 2.
    - To exit the Caller List, press **[OFF]**.
- You cannot store Caller List items in the phone book if a phone number is not displayed.
  - Even if the Caller ID Number Auto Edit feature is turned on, phone numbers in the Caller List and the phone book will not be updated by storing an edited number in the phone book (p. 43, 44).

## Erasing Caller Information **Handset**

### To erase a specific caller

- 1 Press [▼] or [▲] to enter the Caller List.
- 2 Scroll to the desired caller by pressing [▼] or [▲].
- 3 Press the soft key (**ERASE**).
  - “Erased” is displayed.
  - To erase other items, repeat from step 2.
  - To exit the Caller List, press **[OFF]**.

### To erase all entries

- 1 Press [▼] or [▲] to enter the Caller List.
  - Before erasing all entries, make sure that “0 missed call” is displayed.
- 2 Press the soft key (**ERASE**).
  - “All erase?” is displayed.
  - To cancel erasing, press the soft key (**NO**).
- 3 Press the soft key (**YES**).
  - “All erased” is displayed and all entries in your Caller List are erased.

# Phone Book

The handset can store up to 50 names and phone numbers in its phone book. You can make a call by selecting a name or number from the phone book.

## Storing Names and Numbers **Handset**

**1** Press the soft key (**SEARCH**), then press the soft key (📖).

- The display will show the number of stored items.

```
Phone book
  10 items
0-9=Name search
▼▲=Scroll list
```

**2** Press the soft key (**ADD**).

**3** Enter a name of up to 16 characters with the dialing buttons ([0] to [9]) (p. 47), then press [▼].

- To move the cursor, press the soft key (◀) or (▶).
- If a name is not required, press [▼] then go to step 4.

```
Enter name
Tom
▼=Next
```

**4** Enter a phone number of up to 32 digits.

- To delete a digit, press the soft key (**CLEAR**). To erase all of the digits, press and hold the soft key (**CLEAR**).

```
Enter phone no.
5557654321
▼=Next
```

**5** Press [▼].

- If you want to change the name, press the soft key (**EDIT**). The display returns to step 3. Change the name.
- If you want to change the number, press [▲]. The display returns to step 4. Change the number.

```
Tom
555-765-4321
```

**6** Press the soft key (**SAVE**).

- To continue storing other items, repeat from step 2.



**7** Press **[OFF]**.

- In step 1, you can also enter the phone book from the function menu: (1) press **[MENU]**, (2) scroll to “**Phone book**” by pressing [▼] or [▲], then (3) press the soft key (**SELECT**).
- If a pause is required when dialing, press **[REDIAL/PAUSE]** in step 4. A pause is stored in a phone number as one digit (p. 58).
- To store numbers for calling card access (see “Chain Dial” on page 49), we recommend you add pauses after each item. Storing pauses with numbers will prevent misdialing (p. 58). The delay time necessary will depend on your telephone company.

## Selecting characters to enter names

Enter names using the dialing buttons. Press each button until the desired character is displayed.

- Pressing each button selects a character in the order shown below.

Keys	Characters	Keys	Characters
[1]	# & ' ( ) * , - . / 1	[6]	m n o M N O 6
[2]	a b c A B C 2	[7]	p q r s P Q R S 7
[3]	d e f D E F 3	[8]	t u v T U V 8
[4]	g h i G H I 4	[9]	w x y z W X Y Z 9
[5]	j k l J K L 5	[0]	0 Space
	Moves the cursor to the left.		
	Moves the cursor to the right. (To enter another character using the same number key, move the cursor to the next space.)		

**For example, to enter “Tom”:**



1. Press [8] 4 times.
2. Press [6] 3 times, then press the soft key () to move the cursor.
3. Press [6] once.

T

To

Tom

## If you make a mistake while entering a name

1. Press the soft key () or () to move the cursor to the incorrect character.
2. Press the soft key (**CLEAR**) to delete the character.
  - Each time you press the soft key (**CLEAR**), a character is erased.
  - To erase all characters, press and hold the soft key (**CLEAR**).
3. Enter the correct character.

## Dialing from the Phone Book **Handset**

- 1 Press the soft key (**SEARCH**), then press the soft key ().
  - The display shows the number of stored items.
  - You can press the soft key (**SEARCH**) to view the first item.

Phone book  
10 items  
0-9=Name search  
▼▲=Scroll list

# Phone Book

- 2 Scroll to the desired item. To scroll down, press [▼]. To scroll up, press [▲].

Items are sorted in the following order:	
1	Alphabet letters (Alphabetical)
2	Space & ' ( ) , - . /
3	Numbers 0 to 9
4	# *
5	Telephone numbers (If no name is stored)

Frank  
555-456-7890

- 3 Press [↶] or [📞].  
OR

Press the soft key (**CALL**), then press a line soft key (**LINE1**) or (**LINE2**).

- The phone number is dialed.

- In step 1, you can also enter the phone book from the function menu:  
(1) press [MENU], (2) scroll to "Phone book" by pressing [▼] or [▲], then  
(3) press the soft key (**SELECT**).
- If "No items stored" is displayed in step 1, the phone book is empty.
- To exit the phone book, press [OFF].

## To search for a name by initial

1. Press the soft key (**SEARCH**), then press the soft key (📖).
2. Press the dialing button for the first letter of the desired name until any name with the same initial is displayed (see the Index table below).  
Ex. To find "Frank", press [3] repeatedly until the first item under "F" is displayed.
  - If there are no items beginning with the character you selected, the first item in the next alphabetical index will be displayed.
3. Press [▼] repeatedly until the desired name is displayed.

### Index table

Keys	Index	Keys	Index
[1]	Symbols, 1	[6]	M, N, O, 6
[2]	A, B, C, 2	[7]	P, Q, R, S, 7
[3]	D, E, F, 3	[8]	T, U, V, 8
[4]	G, H, I, 4	[9]	W, X, Y, Z, 9
[5]	J, K, L, 5	[0]	0, Space



## Chain Dial **Handset**

You can dial a combination of phone book or manual key pad entries while making a call. This feature can be used, for example, to first automatically dial a calling card access number that you have stored in the phone book, then manually or automatically dial your PIN and then automatically dial the destination number from the phone book.

Ex. Using a long distance calling card

- To prevent misdialing, we recommend you add pauses where needed when storing numbers. For example, add pauses after a calling card access number and your PIN when storing in the phone book (p. 46).
1. Search and dial from the phone book: 1-800-012-3456 (Calling card access number)
    - The voice guidance may be announced.
  2. Search and dial from the phone book: 1234 (Calling card PIN)
  3. Search and dial from the phone book: 1-555-012-3456 (Destination Number)

<p><b>1 While you are on a call;</b> Press <b>[MENU]</b>.</p>	<pre>1=Phone book 2=Privacy on 3=Booster on</pre>
<p><b>2</b> Press the soft key (<b>SELECT</b>) at “<b>1=Phone book</b>”, or press <b>[1]</b>.</p>	<pre>Phone book 30 items 0-9=Name search ▼▲=Scroll list</pre>
<p><b>3</b> Search for the desired item by pressing <b>[▼]</b> or <b>[▲]</b>.</p> <ul style="list-style-type: none"> <li>• To search for an item by initial, see page 48.</li> </ul>	<pre>Alan 1-555-012-3456</pre>
<p><b>4</b> Press the soft key (<b>CALL</b>).</p> <ul style="list-style-type: none"> <li>• The phone number is dialed.</li> <li>• If required, repeat steps 1 to 4 for any remaining numbers.</li> </ul>	

- If you have rotary or pulse service, you need to press **[\*]** before pressing **[MENU]** in step 1 to change the dialing mode temporarily to tone.

# Phone Book

## Editing an Item in the Phone Book **Handset**

1 Press the soft key (**SEARCH**), then press the soft key (📖).

2 Scroll to the desired item by pressing [▼] or [▲].

- To search for the item by initial, see page 48.

3 Press the soft key (**EDIT**).

Enter name  
Jane  
▼=Next

4 Edit the name (p. 47), then press [▼].

- If you do not need to change the name, press [▼] then go to step 5.
- To move the cursor, press the soft key (◀) or (▶).

Enter name  
Jane Walker  
▼=Next

5 Edit the phone number, then press [▼].

- If you do not need to change the number, press [▼] then go to step 6.
- To delete a digit, press the soft key (**CLEAR**).  
To delete all of the digits, press and hold the soft key (**CLEAR**).

Enter phone no.  
5554567890  
▼=Next

6 Press the soft key (**SAVE**).

- To continue editing other items, repeat from step 2.

7 Press **[OFF]**.

## Erasing an Item in the Phone Book **Handset**

1 Press the soft key (**SEARCH**), then press the soft key (📖).

2 Scroll to the desired item by pressing [▼] or [▲].

- To search for the item by initial, see page 48.

3 Press the soft key (**ERASE**).

- To cancel erasing, press the soft key (**NO**).

Erase?

4 Press the soft key (**YES**).

- To erase other items, repeat from step 2.

Erased

5 Press **[OFF]**.

# Speed Dialer

---

## Storing Phone Numbers

You can store up to 10 phone numbers in the base unit. The dialing buttons ([0] to [9]) function as memory stations.

**Make sure the base unit is not being used.**

- If a pause is required when dialing, press **[REDIAL/PAUSE]** where needed. “ ” is displayed when **[REDIAL/PAUSE]** is pressed. A pause counts as one digit (p. 58).
- When **[\*]** is pressed, “ ” is displayed. When **[#]** is pressed, “ ” is displayed.
- If a phone number is stored in a memory location which already contains a phone number, the old number will be erased.
- We recommend you make a note of which phone numbers are stored in which memory locations.

### To erase a stored number

1. Press

# Intercom

---

Intercom calls can be made between the handset and the base unit.

## Making Intercom Calls

### From **Handset**

**1** Press [**HOLD/INTERCOM**].

- The paged unit will ring for 1 minute.
- To stop paging, press [**OFF**].

Calling Base

**2** When the paged party answers, start talking.

- You can switch to the speaker by pressing [**↔**].  
To switch back to the receiver, press [**↶**].

Intercom  
00-00-05

**3** To disconnect the intercom, press [**OFF**].

### From **Base Unit**

Using this feature, you can also locate a misplaced handset.

**1** Press [**LOCATOR/INTERCOM/TRANSFER**].

- The LOCATOR/INTERCOM/TRANSFER and SP-PHONE indicators light.
- The handset will ring for 1 minute.
- To stop paging, press [**SP-PHONE**] or [**LOCATOR/INTERCOM/TRANSFER**].

**2** When the paged party answers, talk into the **MIC**.

**3** To disconnect the intercom, press [**SP-PHONE**] or [**LOCATOR/INTERCOM/TRANSFER**].

- The indicator lights go out.

**During an intercom call:**

- If you have difficulty hearing while using the speakerphone on the handset or base unit, decrease the speaker volume by pressing [**▼**].
- If an incoming call is being received, you will hear 2 tones (incoming call tone, p. 61) and the line button on the base unit will flash rapidly.  
To answer the call;
  - if using the handset, press the called line soft key (**LINE1**) or (**LINE2**).
  - if using the base unit, press the called line button.

## Answering Intercom Calls

### Handset

When the handset is paged, it rings and the Ringer/Message Alert indicator flashes rapidly.

**1** Press [↶], [↷] or [HOLD/INTERCOM].

- You can also answer a page by pressing any button except [▼], [▲] or [OFF].

Call from Base

**2** To disconnect the intercom, press [OFF].

- If the Auto Talk feature is turned on (p. 22), you can also answer a page by simply lifting the handset off the base unit.

### Base Unit

When the base unit is being paged, it rings and the LOCATOR/INTERCOM/TRANSFER indicator flashes.

**1** Press [SP-PHONE] or [LOCATOR/INTERCOM/TRANSFER].

**2** To disconnect the intercom, press [SP-PHONE] or [LOCATOR/INTERCOM/TRANSFER].

- The ringer volume for intercom calls follows the higher level of the 2 lines. When the ringer volume is turned off for both lines (p. 23, 24), the handset and the base unit will ring at the low level for intercom calls.
- You cannot change the ringer tone for intercom calls.

# Transferring a Call

---

You can transfer an outside call to the base unit or the handset.

## From the **Handset** to the **Base Unit**

---

### 1 Handset:

(1) During a call, press **[HOLD/INTERCOM]**.

- “**LINE1**” or “**LINE2**” flashes and the call is put on hold.

Ex. LINE 1 on hold.

Press extension#  
to transfer

0=Base 9=Mailbox

**LINE1** **LINE2**

(2) To page the base unit, press **[0]**.

(3) Wait for the paged party to answer, then you can announce the transfer.

- If the paged party does not answer, press the line soft key (**LINE1**) or (**LINE2**) that is flashing to return to the outside call.

---

**2 Base unit:** Press **[SP-PHONE]** or **[LOCATOR/INTERCOM/TRANSFER]** to answer the page.

---

**3 Handset:** To complete the transfer, press **[OFF]**.

---

- If the base unit is in use, the handset display will show “**Busy**” then “**Hold**”. Press the line soft key (**LINE1**) or (**LINE2**) that is flashing to return to the outside call.  
OR

To transfer the call to the Answering System to allow the caller to leave a message, perform the following steps:

(1) Press **[HOLD/INTERCOM]**.

(2) Press **[9]** to transfer the caller to the Answering System greeting (p. 73).

(The caller will hear the greeting and can leave a message after the beep.)

## From the **Base Unit** to the **Handset**

---

### 1 Base unit:

(1) During a call, press **[LOCATOR/INTERCOM/TRANSFER]**.

- The line button flashes and the call is put on hold.

(2) Wait for the handset user to answer, then you can announce the transfer.

- If the paged party does not answer, press the line button that is flashing to return to the outside call.

---

**2 Handset:** Press **[↶]**, **[↷]**, or **[HOLD/INTERCOM]** to answer the page.

- You can also answer a page by pressing any button except **[▼]**, **[▲]** or **[OFF]**.

---

**3 Base unit:** To complete the transfer, press **[SP-PHONE]**.

---

- If the Auto Talk feature is turned on (p. 22), the paged handset user can also answer a page by simply lifting the handset off the base unit.

## Quick call transfer

You can transfer a call without waiting for the paged party to answer.

### From the [REDACTED] to the

1. During a call, press [**HOLD/INTERCOM**].
2. Press [**0**].
3. Press [**OFF**] to hang up.

### From the [REDACTED] to the

1. During a call, press [**LOCATOR/INTERCOM/TRANSFER**].
2. Press [**SP-PHONE**] to hang up.

- The call will be transferred directly.
- The paged party can answer the transferred call:
  - for the handset, press [**↶**], [**↷**], or the line soft key ( ) or ( ).
  - for the base unit, press [**SP-PHONE**] or the line button.
- After the paged party answers, the transfer is complete.
- If the paged party does not answer:
  - for the handset, press the line soft key ( ) or ( ) to return to the outside call.
  - for the base unit, press the line button that is flashing to return to the outside call.
- If the paged party does not answer within 60 seconds after you hang up, your phone will ring and the call will be returned to your phone. You may speak to the caller again by pressing the line soft key ( ) or ( ) on the handset, or the line button on the base unit.

If you do not answer the call within 4 minutes, the call will be disconnected.

After speaking to the caller, the handset user can also **transfer the caller to the Answering System** by performing the following steps:

- (1) Press [**HOLD/INTERCOM**] on the handset.
- (2) Press [**9**] to transfer the caller to the Answering System greeting (p. 73).  
(The caller will hear the greeting and can leave a message after the beep.)

# Conference Calls

---

## Conference call with 2 outside calls

While you are talking with an outside caller, you can make or answer a second call on the other line, and then combine the calls to establish a conference call.

### Handset

---

- 1 During a call, press **[HOLD/INTERCOM]** **2 times** to put the first call on hold.
- 2 To make or answer a second call, select the other line by pressing the line soft key (**LINE1**) or (**LINE2**).
- 3 When the second call is connected, press the soft key (**CONF**) on your unit to make a conference call.

- **To hang up both lines**, press **[OFF]**.
- **To hang up only one line**, press the line soft key (**LINE1**) or (**LINE2**) for the party with which you want to continue talking.
- **To put both lines on hold**, press **[HOLD/INTERCOM]**.  
To talk with only one caller, press the line soft key (**LINE1**) or (**LINE2**) for the party with which you want to continue talking. To resume both lines, press the soft key (**CONF**).

- You cannot call another user to make a conference call. To join the conference call with the handset or base unit, press either line soft key (**LINE1**) or (**LINE2**) on the handset or either line button on the base unit. One more extension can join the conference call.

### Base Unit

---

- 1 During a call, press **[HOLD]** to put the first call on hold.
- 2 Press the other line button to make or answer a second call.
- 3 When the second call is connected, press **[CONF]** on your unit to make a conference call.

- **To hang up both lines**, press **[SP-PHONE]**.
- **To hang up only one line**, press the line button for the party with which you want to continue talking.
- **To put both lines on hold**, press **[HOLD]**. To talk with only one caller, press the line button. To resume both lines, press **[CONF]**.



## Conference with an outside call and an intercom call

While you are talking with an outside caller, another user can join the conversation using the handset or the base unit and establish a conference call.

### Handset

- 1 During a call, press **[HOLD/INTERCOM]**.
  - The call is put on hold.
- 2 To page the base unit, press **[0]**.
- 3 When the paged party answers, press the soft key (**CONF**) on your unit to make a conference call.

### Base Unit

- 1 During a call, press **[LOCATOR/INTERCOM/TRANSFER]** to page the handset.
  - The call is put on hold.
- 2 When the paged party answers, press **[CONF]** on your unit to make a conference call.

- To leave the conference, press **[OFF]** on the handset or press **[SP-PHONE]** on the base unit. The 2 other parties can continue the conversation.
- During a conference, the outside call can be placed on hold by pressing **[HOLD/INTERCOM]** on the handset or **[HOLD]** on the base unit. Internal communications between the handset and base unit are not suspended. Only the person who placed the call on hold can resume the full conference by pressing the soft key (**CONF**) on the handset or **[CONF]** on the base unit.

## Call Share

This feature allows the base unit or the handset to join an existing outside call.

- To prevent the base unit from joining your conversation, turn the Call Privacy feature on (p. 58).
- A maximum of 4 parties including 1 or 2 outside parties can join a conversation.

## To join a conversation (Call Share)

**Handset** Press the line soft key (**LINE1**) or (**LINE2**).

- “Conference” is displayed.

**Base Unit** Press the line button.

# Special Features

## Muting Your Conversation

During a call, you can mute your phone so the other party cannot listen to you. When muting your conversation, you can hear the other party.

**Handset** Press the soft key (**MUTE**).

- “**Mute**” will be displayed for a few seconds and “**MUTE**” will flash.
- **To release the mute**, press the soft key (**MUTE**) again.
- If you press [**↶**] or [**↷**] to switch between the receiver and speaker, the mute will be released.

**Base Unit** Press [**MUTE**].

- The SP-PHONE indicator flashes.
- **To release the mute**, press [**MUTE**] again or press [**SP-PHONE**].

## Call Privacy **Handset**

Call Privacy allows you to prevent other users from joining your conversation with an outside caller. To allow other users to join your conversation, leave this feature off. This feature is only available for the handset.

### To turn the Call Privacy feature on

1. Press [**MENU**] during an outside call.
2. Press [**2**] to select “**2=Privacy on**”.
  - “**PRIVACY**” is displayed when this feature is turned on.

1=Phone book
2=Privacy on
3=Booster on

**To turn this feature off**, press [**2**] to select “**2=Privacy off**” in step 2.

- In step 2, you can also select “**2=Privacy on**” or “**2=Privacy off**” by pressing [**▼**] or [**▲**] then pressing the soft key (**SELECT**).
- While the Call Privacy feature is turned on, other users cannot join the conversation.
- Call Privacy will turn off after you hang up the call.

## Using the PAUSE Button (For PBX Line/Long Distance Calls)

**Handset** **Base Unit**

We recommend you press [**REDIAL/PAUSE**] if a pause is required for dialing with a PBX or to make a long distance call.

Ex. Line access number [**9**] (PBX)

[**9**] ➔ [**REDIAL/PAUSE**] ➔ 

Phone number
--------------

- Pressing [**REDIAL/PAUSE**] once creates a 3.5 second pause. This prevents misdialing when you dial after confirming the entered number (p. 33) or dial a stored number (p. 47, 49, 51).
- Pressing [**REDIAL/PAUSE**] more than once increases the length of the pause between numbers.

## Temporary Tone Dialing

(For Rotary or Pulse Service Users) **Handset** **Base Unit**

Press [\*] (TONE) before entering access numbers which require tone dialing.

- The dialing mode changes to tone. You can enter numbers to access an answering service, electronic banking service, etc. When you hang up, the dialing mode will return to pulse.

## For Call Waiting Service Users **Handset** **Base Unit**

If another call is received on the same line during a conversation, you will hear a call waiting tone. Press [FLASH/CALL WAIT] to answer the second call.

- The first call is put on hold.
- To return to the first caller, press [FLASH/CALL WAIT] again.
- Call Waiting service cannot be used when:
  - the first call on the same line is put on hold,
  - the Answering System is handling a call on the same line, or
  - you are having a conference call on both lines.
- If this function does not operate properly, consult your telephone company for details.

## Call Waiting Caller ID display **Handset**

If you subscribe to both Caller ID and Call Waiting with Caller ID services (CWID), when a second call is received on the same line while talking, the second caller's information will be displayed. After you hear a call waiting tone while talking, the display shows the caller's name with the phone number, "Waiting" and the line.

BROWN, NANCY
1-555-666-7777
-Waiting--Line1-

- Contact your telephone company for details about availability in your area, and to verify that CWID service is activated on your telephone line.
- The caller's information will only be shown on the display of the handset which is on the outside call on the same line.

# Special Features

## FLASH Button **Handset** **Base Unit**

Pressing **[FLASH/CALL WAIT]** allows you to use special features of your host PBX such as transferring an extension call, or accessing optional telephone services such as call waiting.

- Pressing **[FLASH/CALL WAIT]** cancels the mute (p. 58) or the Temporary Tone Dialing mode (p. 59).

## Selecting the flash time **Handset**

The flash time depends on your telephone exchange or host PBX.

You can select the following flash times: “700, 600, 400, 300, 250, 110, 100 or 90 ms (milliseconds)”. Each line has its own setting. The factory preset for both lines is “700 ms”.

- The setting should stay at 700 ms unless pressing **[FLASH/CALL WAIT]** fails to pick up the Call Waiting call.
- If PBX functions do not work correctly, consult your PBX supplier for the correct settings.

**1** Press **[MENU]**.

**2** Scroll to “Initial setting” by pressing **[▼]** or **[▲]**, then press the soft key (**SELECT**).

Initial setting

**3** Scroll to “Set tel line” by pressing **[▼]** or **[▲]**, then press the soft key (**SELECT**).

Set tel line

**4** Scroll to “Set flash time” by pressing **[▼]** or **[▲]**, then press the soft key (**SELECT**).

Set flash time

**5** Press **[▼]** (**Line1**) or **[▲]** (**Line2**) to select the line.

Set flash time

▼=Line1 ▲=Line2

**6** Select the flash time by pressing **[▼]** or **[▲]**.

Set flash time  
Line1:700ms

**7** Press the soft key (**SAVE**).

- To select the other line, repeat from step 4.

**8** Press **[OFF]**.

## Incoming Call Tone **Handset** **Base Unit**

During an outside call, you can be informed of another incoming call on the other line. During an intercom call (p. 52), you can also be informed of incoming calls by 2 tones. If this feature is turned on, incoming call tones will be heard for as long as the line is ringing. If this feature is set to “2”, incoming call tones will be heard only 2 times. If this feature is turned off, no tones will be heard. This factory preset is “2”. Using the handset, this feature can be set separately for the handset and base unit.

### Handset incoming call tone **Handset**

1 Press <b>[MENU]</b> .	
2 Scroll to “ <b>Ringer setting</b> ” by pressing <b>[▼]</b> or <b>[▲]</b> , then press the soft key ( <b>SELECT</b> ).	Ringer setting
3 Scroll to “ <b>Incoming call.</b> ” by pressing <b>[▼]</b> or <b>[▲]</b> , then press the soft key ( <b>SELECT</b> ).	Incoming call.
4 Select “On”, “Off” or “2” by pressing <b>[▼]</b> or <b>[▲]</b> .	Incoming call tone :2
5 Press the soft key ( <b>SAVE</b> ), then press <b>[OFF]</b> .	

### Base unit incoming call tone **Handset**

1 Press <b>[MENU]</b> .	
2 Scroll to “ <b>Initial setting</b> ” by pressing <b>[▼]</b> or <b>[▲]</b> , then press the soft key ( <b>SELECT</b> ).	Initial setting
3 Scroll to “ <b>Set base unit</b> ” by pressing <b>[▼]</b> or <b>[▲]</b> , then press the soft key ( <b>SELECT</b> ).	Set base unit
4 Scroll to “ <b>Incoming call.</b> ” by pressing <b>[▼]</b> or <b>[▲]</b> , then press the soft key ( <b>SELECT</b> ).	Incoming call.
5 Select “On”, “Off” or “2” by pressing <b>[▼]</b> or <b>[▲]</b> .	Incoming call tone :2
6 Press the soft key ( <b>SAVE</b> ), then press <b>[OFF]</b> .	

# Special Features

---

## Line Selection

When you make or answer a call, the handset and base unit can automatically select the line when you press [↶] or [↷] on the handset or [SP-PHONE] on the base unit. There are 3 types of line selection. You can change the line selection for the handset and base unit separately. The factory preset is “Auto”.

**Auto** (factory preset):

When making a call, LINE 1 will be selected. If that line is unavailable, LINE 2 will be selected. When answering a call, the ringing line will be selected.

- When you call back from the Caller List (p. 42), the indicated line will be selected.
- If the Auto Talk feature is turned on (p. 22), the unit will select the ringing line when you lift the handset off the base unit, to answer the call.

**Line 1:** Line 1 will be selected.

**Line 2:** Line 2 will be selected.

You can select any line by pressing a line soft key (**LINE1**) or (**LINE2**) on the handset or a line button on the base unit, regardless of this setting.

### Handset line selection **Handset**

---

1 Press [MENU].	
2 Scroll to “Initial setting” by pressing [▼] or [▲], then press the soft key ( <b>SELECT</b> ).	Initial setting
3 Scroll to “Set tel line” by pressing [▼] or [▲], then press the soft key ( <b>SELECT</b> ).	Set tel line
4 Press the soft key ( <b>SELECT</b> ) at “Line selection”.	Line selection
5 Select “Line1”, “Line2” or “Auto” by pressing [▼] or [▲].	Line selection :Auto
6 Press the soft key ( <b>SAVE</b> ), then press [OFF].	

---

## Base unit line selection **Handset**

1 Press <b>[MENU]</b> .	
2 Scroll to “ <b>Initial setting</b> ” by pressing <b>[▼]</b> or <b>[▲]</b> , then press the soft key ( <b>SELECT</b> ).	Initial setting
3 Scroll to “ <b>Set base unit</b> ” by pressing <b>[▼]</b> or <b>[▲]</b> , then press the soft key ( <b>SELECT</b> ).	Set base unit
4 Scroll to “ <b>Line selection</b> ” by pressing <b>[▼]</b> or <b>[▲]</b> , then press the soft key ( <b>SELECT</b> ).	Line selection
5 Select “ <b>Line1</b> ”, “ <b>Line2</b> ” or “ <b>Auto</b> ” by pressing <b>[▼]</b> or <b>[▲]</b> .	Line selection :Auto
6 Press the soft key ( <b>SAVE</b> ), then press <b>[OFF]</b> .	

## Key Tone **Handset**

You can select whether or not the handset keys will sound tones (key tone, confirmation tone, error tone). The factory preset is ON.

1 Press <b>[MENU]</b> .	
2 Scroll to “ <b>Initial setting</b> ” by pressing <b>[▼]</b> or <b>[▲]</b> , then press the soft key ( <b>SELECT</b> ).	Initial setting
3 Scroll to “ <b>Key tone</b> ” by pressing <b>[▼]</b> or <b>[▲]</b> , then press the soft key ( <b>SELECT</b> ).	Key tone
4 Select “ <b>Off</b> ” or “ <b>On</b> ” by pressing <b>[▼]</b> or <b>[▲]</b> .	Key tone :On
5 Press the soft key ( <b>SAVE</b> ), then press <b>[OFF]</b> .	

# Special Features

## Re-registering the Handset **Handset & Base Unit**

If “No link to base. Move closer to base and try again.” is displayed even when using the handset near the base unit, the handset may have lost communication with the base unit. You need to re-register the handset to that base unit.

**Make sure the base unit is not being used. Have both the handset and base unit nearby during registration.**

**1 Handset:** Press **[MENU]**.

**2 Handset:**  
Scroll to “**Initial setting**” by pressing **[▼]** or **[▲]**, then press the soft key (**SELECT**).



Initial setting

**3 Handset:**  
Scroll to “**Registration**” by pressing **[▼]** or **[▲]**, then press the soft key (**SELECT**).



Registration

**4 Base unit:**  
Press and hold **[LOCATOR/INTERCOM/TRANSFER]** for 3 seconds.

- The CHARGE indicator flashes. After the CHARGE indicator starts flashing, the rest of the procedure must be completed within 1 minute.

**5 Handset:**  
(1) Press the soft key (**OK**).  
(2) Wait until a long beep sounds and the display shows the following.

- Registration is complete.

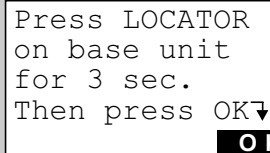

Press LOCATOR  
on base unit  
for 3 sec.  
Then press OK

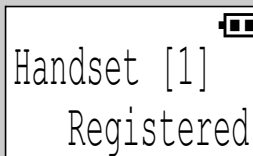

Handset [1]  
Registered

- You can stop registration by pressing **[OFF]** on the handset and pressing **[LOCATOR/INTERCOM/TRANSFER]** on the base unit.



# Automatic Answering Operation

The Answering System allows the unit to answer calls with a greeting message. Callers can then leave a message. When turning the Answering System on, you can select the lines it will answer calls from.

- The total recording time of all messages (greeting, incoming and memo) is **about 60 minutes** (about 30 minutes in “Enhanced recording” mode, p. 31). If messages are recorded in noisy rooms, the time may be shortened by up to 3 minutes.
- To select the caller’s recording time, see page 29.
- A maximum of 99 messages (including the greeting and memo messages) can be recorded.

## Setting the Unit to Answer Calls **Base Unit**

- 1** To turn on the Answering System for both lines, press **[LINE SELECT]** repeatedly until “LINE 1 and LINE 2” is announced.

To turn on the Answering System for either line, press **[LINE SELECT]** repeatedly until “LINE 1” or “LINE 2” is announced.

- The selected line(s) (**LINE 1** and/or **LINE 2**) will be displayed.

**[ANSWER ON]** and Indicator **[LINE SELECT]**

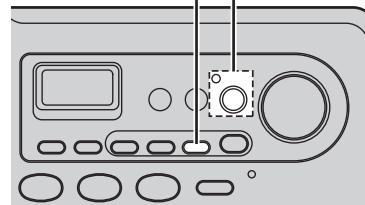

- 2** Press **[ANSWER ON]** to turn on the Answering System for the line(s).

- The indicator lights.
- The unit announces “Answer set” and the line(s), and the current day and time. If “Set time” is heard, set the date and time (p. 19).

- The number of caller messages and memo messages will be displayed on the base unit (p. 67). If the Answering System is turned on for only one of the 2 lines, the display shows the number of messages recorded for that line (not both lines) plus the number of memo messages. The number of messages continues to be displayed if the Answering System is turned off.
- The unit will announce the remaining recording time if it is less than 10 minutes.
- When no recording time is available, you will need to erase any unnecessary messages before new messages can be recorded (p. 71). The unit can indicate that memory is full in the following ways:
  - “**FULL**” will flash on the base unit and the ANSWER ON indicator will flash rapidly.
  - The unit will announce “Memory full” when you press **[ANSWER ON]**, **[GREETING REC]**, or **[MEMO]**, and after playing back messages or recording a message.
- You can also turn on the Answering System remotely from the handset (p. 70) or an outside phone (p. 77).
- If you subscribe to Caller ID (p. 40), Caller ID information automatically adjusts the date and time when a call is received, provided you have already set the date and time manually (p. 19).

# Automatic Answering Operation

---

## To turn off the Answering System

Press **[ANSWER ON]**.

- The indicator light goes out, and the unit announces “Answer off”.
- To turn the Answering System off for one line when both lines are turned on, select the line which you want to leave on by pressing **[LINE SELECT]**, then press **[ANSWER ON]**.

## Monitoring Incoming Calls **Base Unit**

While a caller is leaving a message, you can monitor the call through the base unit speaker.

- To increase the speaker volume while monitoring, press **[▲]**. To decrease volume, press **[▼]**.
- If both lines are receiving calls at the same time, only the first call can be monitored.

To answer a call while monitoring, press the called line button on the base unit, or press the called line soft key (**LINE1**) or (**LINE2**) on the handset.

### To turn the incoming call monitoring feature off

When the base unit is not in use, press **[▼]** repeatedly until “0” is displayed. (Make sure the Answering System is turned on.)

OR

While monitoring, press **[▼]** repeatedly until “0” is displayed.

- If the incoming call monitoring feature is turned off, it will remain off when the next call is monitored.
- If you adjust the speaker volume while playing back messages or using the speakerphone, the speaker volume for monitoring will be turned on again. To turn the speaker volume off, see “To turn the incoming call monitoring feature off” of above step.

# Listening to Messages

**Voice Day/Time Stamp:** During playback, the unit will announce the day and time when each message was recorded (p. 19).

The unit will indicate that new messages have been recorded in the following ways:

- The NEW MESSAGE indicator flashes on the base unit.
- “New message” is displayed and “SEARCH” flashes on the handset.
- The Ringer/Message Alert indicator on the handset will flash slowly when new messages have been recorded if the Message Alert is turned on (p. 31) and the handset is not in use.

The total number of caller messages and memo messages is displayed on the base unit. If the Answering System is turned on for only one of the 2 lines, the display shows the number of messages recorded for that line (not both lines) plus the number of memo messages. The number of messages continues to be displayed if the Answering System is turned off.

## Using the Base Unit **Base Unit**

### To play back messages

Press **[MESSAGE]**.

- The unit announces the number of new messages. Only new messages are played back.
- When there are no new messages, the unit announces “No new messages. All message playback”, then plays back all messages.
- When there are no messages, the unit announces “No messages”.

NEW MESSAGE Indicator

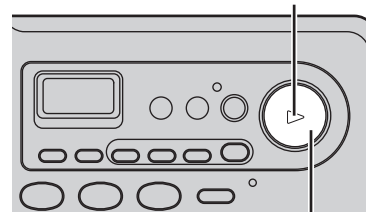

**[MESSAGE]**

### To play back messages for the desired line(s)

1. Press **[LINE SELECT]** repeatedly until the unit announces the desired line(s).

- The selected line(s) (**LINE 1** and/or **LINE 2**) will be displayed.

Ex. 2 messages for LINE 1



2. Press **[MESSAGE]**.

- The unit announces the number of new messages for the line(s). Only new messages are played back. Memo messages are not played back.
- When there are no new messages, the unit announces “No new messages. All message playback”, then plays back all messages.
- When there are no messages, the unit announces “No messages”.
- While a message is being played, the message number is displayed, and the line (**LINE 1** or **LINE 2**) flashes on the base unit.
- At the end of the last message, “End of final message” is heard. The unit will announce the remaining recording time if it is less than 10 minutes.

Answering System

# Listening to Messages

---

- If a call is received during playback, the unit rings and playback stops. To answer the call, press the called line button. For playback, start again from the beginning after hanging up.
- If 65 or more new messages have been recorded, the unit will not announce the number of new messages during playback.

## Using the Handset (Remote Operation)

When “ ” flashes and “**New message**” is displayed, new messages have been recorded. If there are only old messages, “ ” is displayed but will not flash.

### To play back messages

**1** Press the soft key ( ).

- When there are new messages, “ ” flashes. If there are only old messages “ ” is displayed but will not flash.

**2** Press the soft key ( ).

- The unit beeps, then announces the number of new messages. Only new messages are played back.
- To switch from the speaker to the receiver, press [↶]. To switch back to the speaker, press [↷].
- When there are no new messages, the unit announces “No new messages. All message playback”, then plays back all messages.
- When there are no messages, the unit announces “No messages”.
- To play all messages, press [5].
- If you do not press any button, the voice menu will start (p. 69).

**3** To end remote operation, press [OFF].

### To play back messages from the function menu

Press [MENU], then press the soft key ( ) at “**Message play**”, instead of pressing the soft key ( ) then the soft key ( ).

# Listening to Messages

## To play back messages for the desired line(s)

1. Press the soft key (**SEARCH**), then press the soft key (**PLAY**).
2. To listen to messages for LINE 1, press **#[1]**.  
To listen to messages for LINE 2, press **#[2]**.  
To listen to messages for LINE 1 and LINE 2, press **#[0]**.
  - The unit announces the number of new messages for the line(s). Only new messages are played back. Memo messages are not played back.
  - When there are no new messages, the unit announces “No new messages. All message playback”, then plays back all messages.
  - When there are no messages, the unit announces “No messages”.
3. To end remote operation, press **[OFF]**.
  - If a call is received during playback, the unit rings and playback stops. To answer the call, press the called line soft key (**LINE1**) or (**LINE2**). For playback, start again from the beginning after hanging up.
  - At the end of the last message, “End of final message” is heard. The unit will announce the remaining recording time if it is less than 10 minutes.
  - If you hear “Memory full” after playback, erase unnecessary messages (p. 71).
  - When memo messages are played (p. 72), **MEMO** is displayed.
  - If 65 or more new messages have been recorded, the unit will not announce the number of new messages during playback.

## Voice menu

If you do not press any buttons at the end of the last message, the unit will announce “End of final message” and the voice menu will begin. The unit announces, “Press 4 to play back new messages. Press 5 to play back all messages.”

- Even if the voice menu has started;
  - you can press buttons for other playback options (p. 70), or
  - you can select the line(s) by pressing **#[1]** (LINE 1), **#[2]** (LINE 2) or **#[0]** (LINE 1 and LINE 2).
- If you do not press any button within 10 seconds after the voice menu, the handset will exit remote operation.

# Listening to Messages

## For Caller ID service users (p. 40)

During playback, the handset display shows the name and/or number of the caller whose message is being played.

### To call the displayed number:

1. Press the soft key (**CALL**).
    - The unit stops playback.
    - If you need to edit the phone number to call back, see page 44.
  2. Press the line soft key (**LINE1**) or (**LINE2**).
    - The unit dials the phone number.
- OR
- Press [] or [].
- The unit dials the phone number using the called line.

## To turn the Answering System on

1. During playback, select the desired line(s) by pressing **#[1]** (LINE 1), **#[2]** (LINE 2) or **#[0]** (LINE 1 and LINE 2).
  - If the Answering System is turned on for one line and you also want to turn on the system for the other line, select both lines.
2. To turn the system on for the line(s), press **[8]**.

To turn the Answering System off, press **[0]** during playback.

- To turn the Answering System off for one line when both lines are turned on, select the line which you want to leave on (see step 1 above), then press **[8]**.

## During playback **Base Unit** **Handset**

<b>To adjust the speaker volume</b>	To increase, press [ <b>▲</b> ]. To decrease, press [ <b>▼</b> ]. • You can also adjust the receiver volume on the handset.
<b>To repeat a message</b>	<i>Base unit:</i> Press [ <b>◀◀</b> ]. <i>Handset:</i> Press the soft key ( <b>REPEAT</b> ) or <b>[1]</b> . • If pressed within the first 5 seconds of playback, the previous message will be played.
<b>To skip a message</b>	<i>Base unit:</i> Press [ <b>▶▶</b> ]. <i>Handset:</i> Press the soft key ( <b>SKIP</b> ) or <b>[2]</b> .
<b>To stop playback</b>	<i>Base unit:</i> Press [ <b>STOP</b> ]. • To resume playback, press [ <b>MESSAGE</b> ]. • If you do not press any button for 60 seconds or if you press [ <b>STOP</b> ] again, playback mode will be canceled. <i>Handset:</i> Press <b>[9]</b> . • If you do not press any button within 15 seconds after stopping playback, the voice menu will start (p. 69).

# Erasing Messages

The unit will announce the remaining recording time after playback if it is less than 10 minutes. New messages cannot be recorded when:

- “Memory full” is heard.
- “**FULL**” flashes on the base unit.
- ANSWER ON indicator flashes rapidly (when the Answering System is on).

Erase unnecessary messages. We recommend you erase unnecessary messages after each playback.

## Erasing a specific message

### Base Unit

Press **[ERASE]** while the message you want to erase is being played.

- A beep sounds, then the next message is played. To exit playback mode, press **[STOP]** 2 times.

### Handset

Press **[\*][4]** while the message you want to erase is being played.

- A beep sounds, then the next message is played. To exit remote operation mode, press **[OFF]**.

## Erasing all messages

You can erase all caller messages and all memo messages in one operation.

- The greeting message(s) will not be erased.
- If the Answering System was turned on for only one of the 2 lines, only caller messages for that line and memo messages are erased. Caller messages recorded for the other line are not erased.

If you want to erase caller messages only for the desired line(s), select the line(s).

### Base Unit

---

**1** Press **[ERASE]** while the base unit is not being used.

- “To erase all messages, press ERASE again” is heard.

---

**2** Within 10 seconds, press **[ERASE]** again. Wait until “No messages” is heard.

- While erasing messages, alarm tones will be heard.
  - All messages for the line(s) and memo messages are erased.
- 

### To erase all messages for the desired line(s)

1. Select the line(s) by pressing **[LINE SELECT]**.
2. Press **[ERASE]**.
3. Within 10 seconds, press **[ERASE]** again. Wait until “No messages” is heard.
  - While erasing messages, alarm tones will be heard.
  - All messages for the line(s) are erased. Memo messages are not erased.

# Erasing Messages

---

## Handset

---

- 1 Press the soft key (**SEARCH**), then press the soft key (**PLAY**).
  - 2 Press **[\*][5]** to erase all messages. Wait until “No messages” is heard.
    - While erasing messages, alarm tones will be heard.
    - All messages for the line(s) and memo messages are erased.
    - To end remote operation, press **[OFF]**.
- 
- Information in the Caller List will not be erased. To erase caller information, see page 45.

### To erase all messages for the desired line(s)

1. Press the soft key (**SEARCH**), then press the soft key (**PLAY**).
2. Select the line(s) by pressing **[#][1]** (LINE 1), **[#][2]** (LINE 2) or **[#][0]** (LINE 1 and LINE 2).
3. Press **[\*][5]** to erase all messages for the line(s). Wait until “No messages” is heard.
  - While erasing messages, alarm tones will be heard.
  - All messages for the line(s) are erased. Memo messages are not erased.
  - To end remote operation, press **[OFF]**.

# Recording a Memo Message

---

## Base Unit

---

You can record a voice memo message of up to 3 minutes for other users or yourself.

---

- 1 Press **[MEMO]**.
  - 2 After the long beep, talk clearly 20 cm (8 inches) away from the **MIC**.
    - The base unit display shows the elapsed recording time.
    - If the elapsed recording time exceeds 99 seconds, the counter continues from 00 to indicate 100 seconds.
  - 3 When finished, press **[MEMO]** or **[STOP]**.
    - The NEW MESSAGE indicator flashes.
- 
- If you record for over 3 minutes in step 2, the unit will stop recording.
  - If “E” is displayed, 6 beeps sound and “Your message was not recorded. Record your message again.” is announced, start again from step 1.



# Transferring a Call to the Answering System

## Handset

When you answer a call and the caller wants to talk to someone who is not available, you can transfer the caller to the Answering System, where the caller can leave a message.

Tell the outside caller you will transfer him or her to the Answering System.

**1** Press **[HOLD/INTERCOM]** during a call.

- The call is put on hold.

Handset display

Press extension#  
to transfer

0=Base 9=Mailbox

**2** Press **[9]** to hang up the call.

After you press **[9]**:

The caller will hear the greeting (p. 27), then he or she can leave a message after the beep.

- Even if you subscribe to Caller ID (p. 40), Caller ID information will not be displayed while the message is being played. The Caller ID information will be recorded in the Caller List (p. 41) if the transferred call is an incoming call.
- If you set the caller's recording time to "Greeting only" (p. 29), the caller cannot leave a message.

### Interrupting remote operation

If another user is calling from a remote location to operate the Answering System and you mistakenly answer the call, repeat steps 1 and 2 above.

- The user can then operate the Answering System, by entering the remote code (see "Remote Operation from a Touch Tone Phone" on page 74).

# Remote Operation from a Touch Tone Phone

While outside, you can operate the Answering System from any touch tone phone. A synthesized voice menu will guide you through the Answering System (p. 76).

- To skip the voice menu and operate the unit directly, see page 77.

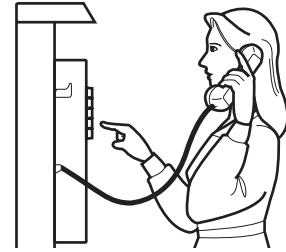

## Summary of remote operation

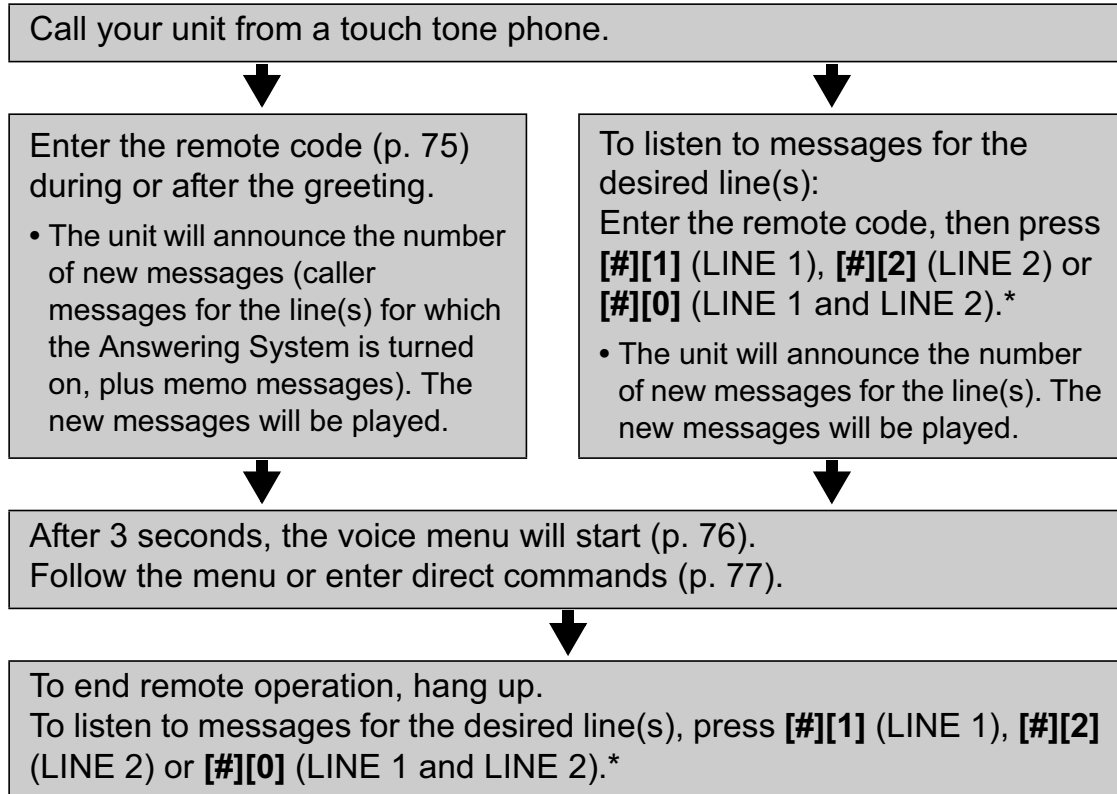

- The unit will announce the remaining recording time after playback if it is less than 10 minutes.
- The messages are saved.
- If the unit announces “No new messages”, there are only old messages. If “No messages” is announced, there are no messages.
- If 65 or more new messages have been recorded, the unit will not announce the number of new messages during playback.

\*After selecting the line(s), messages for the line(s) will be played. Memo messages will not be played.

# Remote Operation from a Touch Tone Phone

## Remote Code **Handset**

The remote code prevents unauthorized people from accessing your unit and listening to your messages. Choose any **2-digit number (00–99)** for your remote code.

The factory preset remote code is “11”. If you do not program your own remote code, you can use “11”.

**1** Press **[MENU]**.

**2** Scroll to “**Initial setting**” by pressing **[▼]** or **[▲]**, then press the soft key (**SELECT**).

Initial setting

**3** Press the soft key (**SELECT**) at “**Set answering**”.

Set answering

**4** Scroll to “**Remote code**” by pressing **[▼]** or **[▲]**, then press the soft key (**SELECT**).

Remote code

**5** Enter a **2-digit remote code (00–99)**.

Ex. Entered 35.

Remote code  
:35

**6** Press the soft key (**SAVE**).

**7** Press **[OFF]**.

**To confirm the remote code**, repeat steps 1 to 4.

- The remote code is displayed. When finished, press **[OFF]**.

# Remote Operation from a Touch Tone Phone

## Voice Menu

The shaded parts are voice prompts.

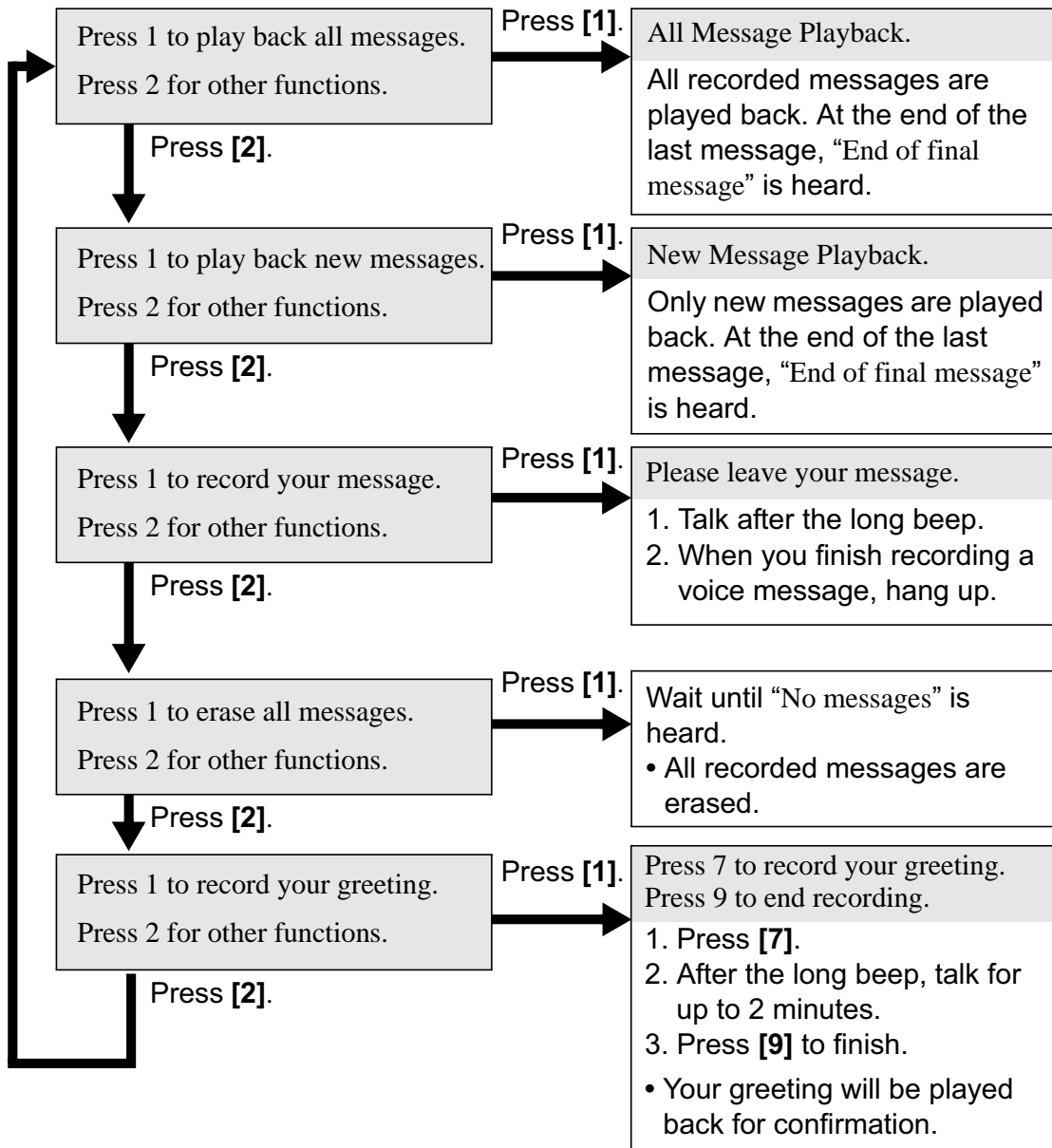

- 3 seconds after playback, the voice menu will start again from the beginning.
- The unit will announce the remaining recording time after playback if it is less than 10 minutes.
- If you hear "Memory full" after playback, erase unnecessary messages (p. 77).
- To listen to messages for the desired line(s), press **#[1]** (LINE 1), **#[2]** (LINE 2) or **#[0]** (LINE 1 and LINE 2). Memo messages will not be played.  
If you erase all messages after selecting the line(s), all messages for the line(s) will be erased. Memo messages will not be erased.
- If you do not press any buttons within 10 seconds after a voice prompt, "Thank you for your call" will be heard and the call will be disconnected.

# Remote Operation from a Touch Tone Phone

## Direct Remote Operation

Once you have entered the remote code (p. 76), you can also control your unit by direct commands instead of using the voice menu. To end the remote operation, hang up at anytime.

### Direct commands

<b>[4]:</b> Plays back new messages.	<b>[*] [4]:</b> Erases the current message. <ul style="list-style-type: none"><li>• A beep will sound and the next message will be played.</li></ul>
<b>[5]:</b> Plays back all messages.	<b>[*] [5]:</b> Erases all messages. Wait until "No messages" is heard. <ul style="list-style-type: none"><li>• To erase all messages for the desired line(s), select the line(s) (see below), then press [*][5]. Memo messages will not be erased.</li></ul>
<b>[1]:</b> Repeats the current message. <ul style="list-style-type: none"><li>• If pressed within the first 5 seconds of playback, the previous message will be played.</li></ul>	<b>[#] [1]:</b> Selects LINE 1.
<b>[2]:</b> Skips the current message.	<b>[#] [2]:</b> Selects LINE 2.
<b>[9]:</b> Stops the current operation. <ul style="list-style-type: none"><li>• To resume, enter a direct command within 15 seconds, or the voice menu will start (p. 76).</li></ul>	<b>[#] [0]:</b> Selects LINE 1 and LINE 2. <ul style="list-style-type: none"><li>• Memo messages will not be played.</li></ul>
<b>[7]:</b> Records a greeting message. ↓ After the long beep, talk for up to 2 minutes.	<b>[#][1][8]:</b> Turns on the Answering System for LINE 1.
<b>[9]:</b> Recording is stopped. <ul style="list-style-type: none"><li>• The greeting is played.</li></ul>	<b>[#][2][8]:</b> Turn on the Answering System for LINE 2.
<b>[0]:</b> Turns off the Answering System.	<b>[#][0][8]:</b> Turns on the Answering System for LINE 1 and LINE 2.

- If the Answering System is turned on for one line and you also want to turn on the system for the other line, press [#][0][8].
- To turn the Answering System off for one line when both lines are turned on, turn the system on for the line which you want to leave on (see above).

## Turning on the Answering System

Call the line for which you turned off the system, and wait for 15 rings.

- The unit will answer and the greeting will be played.
- The Answering System will be turned on. Hang up or enter the remote code for other options.
- When turning on the Answering System using a rotary or pulse service telephone, you cannot enter the remote code for other options.

## Skipping the greeting

After calling your unit, press [\*] during the greeting.

- The unit skips the rest of the greeting and you can start recording your message after the long beep.



## Wall Mounting

- 4** Adjust the adaptor to hold the base unit, then push it in the direction of the arrow until it clicks into place.

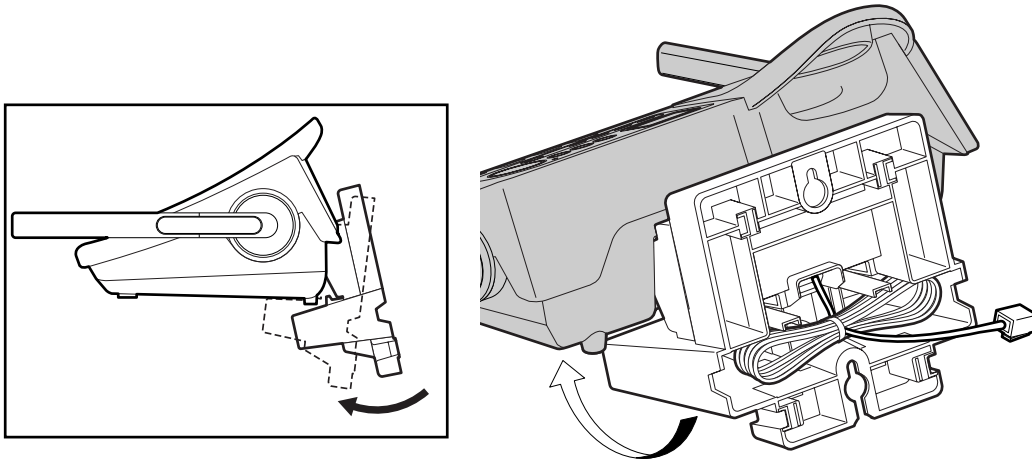

- 5** Connect the telephone line cord. Mount the unit, then slide it down.  
• Raise the antennas.

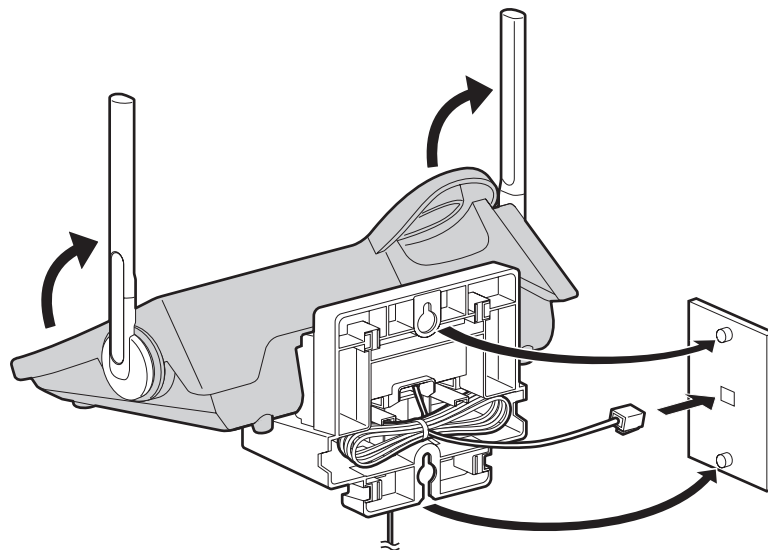

- 6 To charge the handset battery:**  
Place the handset on the base unit.  
• The unit beeps once and the CHARGE indicator lights.

## Wall Mounting

---

### To remove the wall mounting adaptor

While pushing down the RELEASE LEVERS (❶), remove the adaptor (❷).

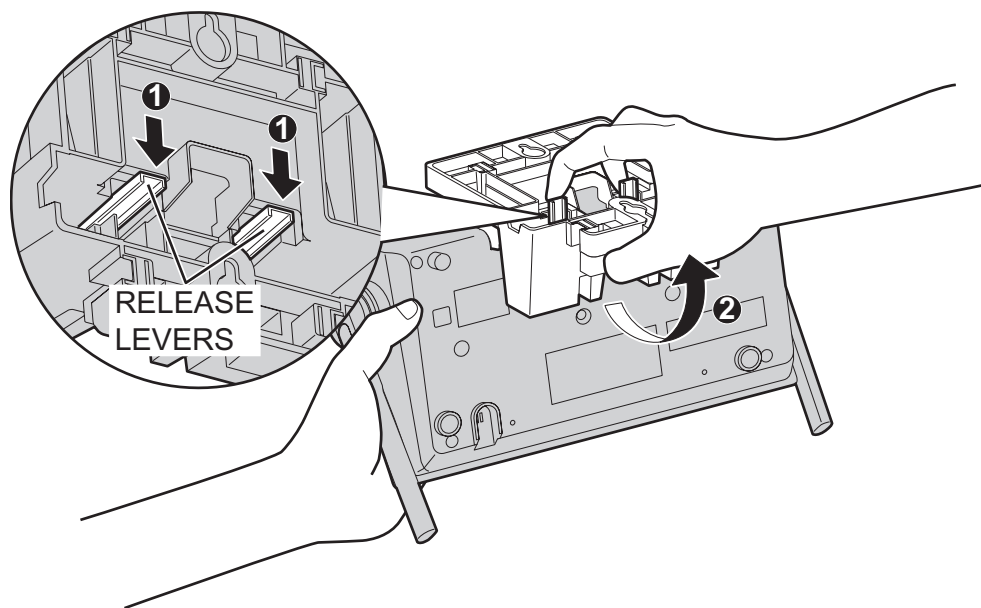



# Belt Clip

You can hang the handset on your belt or pocket using the included belt clip.

## To attach the belt clip

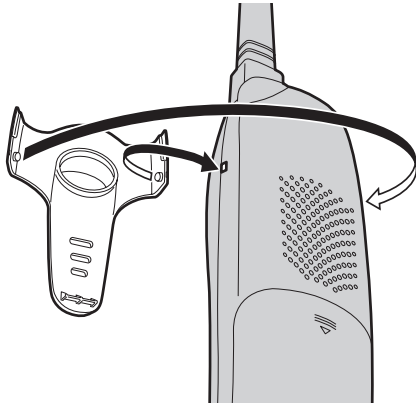

## To remove the belt clip

While pressing the top of the clip (A), pull the right edge in the direction of the arrow (B).

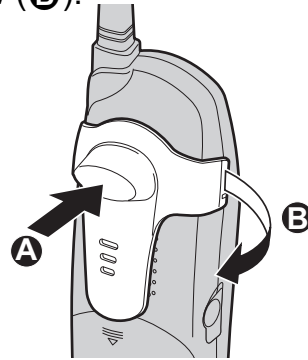

# Optional Headset

Connecting an optional headset to the handset allows hands-free phone conversation. Please use only a Panasonic KX-TCA60, KX-TCA86, KX-TCA88, KX-TCA88HA, KX-TCA91, KX-TCA92, or KX-TCA98 headset. To order, call the accessories telephone number on page 2.

## Connecting an optional headset

Open the headset jack cover, and insert the headset plug into the headset jack as shown below.

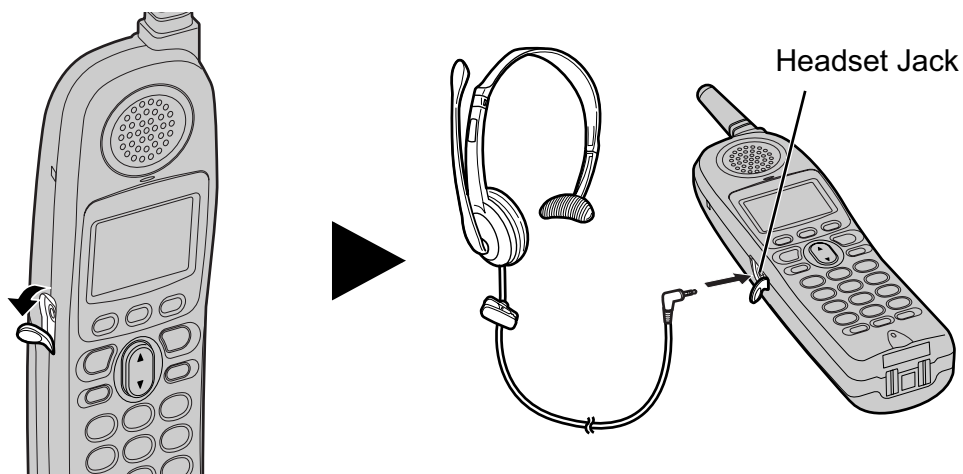

- Headset sold separately. Model shown here is KX-TCA86.

**To switch to the speakerphone while using the headset:**  
Press [📞]. To return to the headset, press [📞].

# Direct Commands

## Handset

After pressing **[MENU]**, you can also program menu items directly by pressing (**[0]** to **[9]**, **[\*]** and **[#]**) instead of using the soft keys.

Menu item		Command	Selection items	Page
Ringer volume (Handset)	Line 1	<b>[1] [1] [1]</b>	<b>[1]</b> : Low <b>[2]</b> : Medium <b>[3]</b> : High <b>[0]</b> : Off	p. 23
	Line 2	<b>[1] [1] [2]</b>		
Ringer tone (Handset)	Line 1	<b>[1] [2] [1]</b>	<b>[1]–[4]</b> : Tone pattern 1–4 <b>[5]–[8]</b> : Melody pattern 1–4	p. 25
	Line 2	<b>[1] [2] [2]</b>		
Incoming call tone (Handset)		<b>[1] [3]</b>	<b>[1]</b> : On <b>[2]</b> : 2 times <b>[0]</b> : Off	p. 61
Message play		<b>[2]</b>	–	p. 68
Date and time		<b>[4]</b>	Go to Step 3 on page 19.	–
Voice enhancer		<b>[5]</b>	<b>[1]</b> : On <b>[0]</b> : Off	p. 35
LCD contrast		<b>[0] [1]</b>	<b>[1]–[6]</b> : Level 1–6	p. 22
Key tone		<b>[0] [2]</b>	<b>[1]</b> : On <b>[0]</b> : Off	p. 63
Auto talk		<b>[0] [3]</b>	<b>[1]</b> : On <b>[0]</b> : Off	p. 22
Caller ID Number Auto Edit		<b>[0] [4]</b>	<b>[1]</b> : On <b>[0]</b> : Off	p. 44
Set dial mode		<b>[0] [5] [1]</b>	<b>[1]</b> : Pulse <b>[2]</b> : Tone	p. 20
Set flash time	Line 1	<b>[0] [5] [2] [1]</b>	<b>[1]</b> : 700 ms <b>[2]</b> : 600 ms <b>[3]</b> : 400 ms <b>[4]</b> : 300 ms <b>[5]</b> : 250 ms <b>[6]</b> : 110 ms <b>[7]</b> : 100 ms <b>[8]</b> : 90 ms	p. 60
	Line 2	<b>[0] [5] [2] [2]</b>		
Set line mode	Line 1	<b>[0] [5] [3] [1]</b>	<b>[1]</b> : A <b>[2]</b> : B	p. 21
	Line 2	<b>[0] [5] [3] [2]</b>		
Line selection (Handset)		<b>[0] [5] [5]</b>	<b>[0]</b> : Auto <b>[1]</b> : Line 1 <b>[2]</b> : Line 2	p. 62
Number of rings	Line 1	<b>[0] [6] [1] [1]</b>	<b>[2]–[7]</b> : 2–7 rings <b>[0]</b> : Toll saver	p. 30
	Line 2	<b>[0] [6] [1] [2]</b>		
Recording time	Line 1	<b>[0] [6] [2] [1]</b>	<b>[1]</b> : 1 minute <b>[2]</b> : 2 minute <b>[3]</b> : 3 minute <b>[0]</b> : Greeting only	p. 29
	Line 2	<b>[0] [6] [2] [2]</b>		
Remote code		<b>[0] [6] [3]</b>	Go to Step 5 on page 75.	–
Recording mode		<b>[0] [6] [4]</b>	<b>[1]</b> : Standard recording (60 min) <b>[2]</b> : Enhanced recording (30 min)	p. 31

## Direct Commands

Menu item		Command	Selection items	Page
Change language		[0] [8]	[1] : English [2] : Spanish	p. 20
Message alert		[0] [#]	[1] : On [0] : Off	p. 31
Ringer tone (Base unit)	Line 1	[0] [*] [1] [1]	[1]–[4] : Tone pattern 1–4 [5]–[8] : Melody pattern 1–4	p. 26
	Line 2	[0] [*] [1] [2]		
Incoming call tone (Base unit)		[0] [*] [2]	[1] : On [2] : 2 times [0] : Off	p. 61
Line selection (Base unit)		[0] [*] [5]	[0] : Auto [1] : Line 1 [2] : Line 2	p. 63
Ringer volume (Base unit)	Line 1	[0] [*] [6] [1]	[1] : Low [2] : Medium [3] : High [0] : Off	p. 24
	Line 2	[0] [*] [6] [2]		
Handset registration		[0] [0]	Go to Step 4 on page 64.	–
Phone book		[*]	To store an item, go to Step 2 on page 46. To search for items, go to Step 2 on page 48.	–

### During programming:

When “**SAVE**” or “**OK**” is displayed, press the right soft key **to save the new settings**.

**To exit programming**, press **[OFF]**.

- If you press the direct command incorrectly, press **[OFF]**, then re-enter programming mode by pressing **[MENU]**.
- For function details, see the corresponding pages.

# If the Following Appear on Your Display...

The following will be displayed on the handset when the unit needs your attention.

Display message	Cause & Remedy
Recharge battery	<ul style="list-style-type: none"> <li>The battery needs to be charged. Recharge the battery (p. 16).</li> </ul>
Charge for 6 HRS	<ul style="list-style-type: none"> <li>The battery has been discharged. The handset will not work. Fully charge the battery (p. 16).</li> </ul>
No link to base. Move closer to base and try again.	<ul style="list-style-type: none"> <li>The handset has lost communication with the base unit. Walk closer to the base unit, and try again.</li> <li>Confirm the base unit's AC adaptor is plugged in.</li> <li>Raise the base unit antennas.</li> <li>The handset's registration may have been canceled. Re-register the handset (p. 64).</li> </ul>
Please lift up and try again.	<ul style="list-style-type: none"> <li>A handset button was pressed while the handset was on the base unit. Lift the handset and press the button again.</li> </ul>
Busy	<ul style="list-style-type: none"> <li>The called base unit is in use.</li> <li>The base unit user is using the line(s). Wait until the line status icon goes out.</li> </ul>
Error!!	<ul style="list-style-type: none"> <li>When you tried to re-register the handset, the handset and base unit could not link for some reason, such as interference from electrical appliances. Move the handset and base unit away from any electrical appliances and try again.</li> </ul>
System is busy. Please try again later.	<ul style="list-style-type: none"> <li>The Answering System is in use (answering a call or playing back messages). Try again later.</li> <li>The handset has lost communication with the base unit. Walk closer to the base unit and try again.</li> </ul>
Phone book full	<ul style="list-style-type: none"> <li>When you tried to store an item in the phone book, the phone book memory was full. Press <b>[OFF]</b> to exit programming mode. To erase other items from the phone book, see page 50.</li> </ul>

# Troubleshooting

If the handset display shows error messages, see “If the Following Appear on Your Display...” (p. 84) for the Cause & Remedy.

## Telephone System

Problem	Cause & Remedy
<p>“No link to base. Move closer to base and try again.” is displayed and an alarm tone sounds.</p>	<ul style="list-style-type: none"> <li>• The handset has lost communication with the base unit. Walk closer to the base unit, and try again.</li> <li>• Confirm the base unit’s AC adaptor is plugged in.</li> <li>• Raise the base unit antennas.</li> <li>• If the above remedies do not solve the problem, the handset may have lost communication with the base unit. Register the handset again (p. 64).</li> </ul>
<p>Static, sound cuts in/out, fades. Interference from other electrical units.</p>	<ul style="list-style-type: none"> <li>• Move the handset and base unit away from other electrical appliances (p. 3).</li> <li>• Walk closer to the base unit.</li> <li>• Raise the base unit antennas.</li> <li>• Turn on the Clarity Booster feature (p. 35).</li> <li>• If the unit is connected to a telephone line with DSL service, you may hear noise from the receiver or speaker during conversations. We recommend connecting a noise filter (contact your DSL service provider) to the telephone line between the base unit and the telephone line jack.</li> </ul>
<p>The base unit/handset does not ring.</p>	<ul style="list-style-type: none"> <li>• The ringer volume is turned off. Set to high, medium, or low (p. 23, 24).</li> </ul>
<p>The handset display is blank.</p>	<ul style="list-style-type: none"> <li>• If the handset display is blank, fully charge the battery (p. 15).</li> </ul>
<p>You cannot program any function items.</p>	<ul style="list-style-type: none"> <li>• Programming is not possible while the handset or base unit is being used.</li> <li>• Do not pause for over 60 seconds while programming.</li> <li>• Walk closer to the base unit.</li> <li>• While another user is listening to messages or the Answering System is handling a call, you cannot program. Try again later.</li> </ul>
<p>While programming or searching, the handset or base unit starts to ring and the program/search stops.</p>	<ul style="list-style-type: none"> <li>• A call is coming in. To answer the call, press [⏪], [⏩], or the called line soft key (<b>LINE1</b>) or (<b>LINE2</b>) on the handset, or press [SP-PHONE] or the called line button on the base unit. Start again from the beginning after hanging up.</li> </ul>

# Troubleshooting

---

Problem	Cause & Remedy
You cannot make an intercom/ outside call.	<ul style="list-style-type: none"><li>• Your handset is in remote operation mode (p. 68). Exit by pressing <b>[OFF]</b>.</li><li>• The handset you called is too far from the base unit.</li></ul>
You cannot redial.	<ul style="list-style-type: none"><li>• If the last number dialed was more than 48 digits long, the number will not be redialed correctly.</li><li>• The <b>[REDIAL/PAUSE]</b> button functions as either redial or pause. It will redial the last number dialed if pressed before dialing any digits (p. 33, 37). If another number has been dialed first, it will operate as a pause button (p. 58).</li></ul>
You cannot make long distance calls.	<ul style="list-style-type: none"><li>• Please make sure you have long distance service.</li></ul>
The handset does not display the caller's name and/or phone number.	<ul style="list-style-type: none"><li>• You have not subscribed to Caller ID service. Contact your telephone company to subscribe.</li><li>• If your unit is connected to any additional telephone equipment such as Caller ID box or wireless telephone jack, disconnect the unit from the equipment and plug the unit directly into the wall jack.</li><li>• If the unit is connected to a telephone line with DSL service, the unit may not display caller's name and/or phone number properly. We recommend connecting a noise filter (contact your DSL service provider) to the telephone line between the unit and the telephone line jack.</li><li>• The name display service may not be available in some areas. Contact your telephone company for details.</li><li>• Other telephone equipment may be interfering with this unit. Disconnect the other equipment and try again.</li><li>• The caller requested not to send caller information (p. 40).</li><li>• If a call is being transferred to you, the caller information will not be displayed.</li><li>• Generally caller information is displayed from the 2nd ring.</li></ul>

# Troubleshooting

Problem	Cause & Remedy
The handset cannot automatically edit the Caller List/incoming phone numbers.	<ul style="list-style-type: none"><li>• The Caller ID Number Auto Edit feature is turned off. Turn it on (p. 44) and try again.</li><li>• You need to press [<b>↶</b>], [<b>↷</b>], or a line soft key (<b>LINE1</b>) or (<b>LINE2</b>) after editing the number.</li></ul>
The handset display exits the Caller List or phone book.	<ul style="list-style-type: none"><li>• Do not pause for over 60 seconds while searching.</li></ul>
The Ringer/Message Alert indicator flashes slowly when the handset is not ringing and in use.	<ul style="list-style-type: none"><li>• The Message Alert is turned on and new messages have been recorded. Turn the Message Alert off (p. 31) or listen to the new messages (p. 67, 68, 74).</li></ul>
You cannot have a conversation using the headset.	<ul style="list-style-type: none"><li>• Make sure the optional headset is connected properly (p. 81).</li><li>• If “<b>SP-phone</b>” is displayed on the handset, press [<b>↶</b>] to switch to the headset.</li></ul>

# Troubleshooting

## Answering System

Problem	Cause & Remedy
The Answering System is on, but incoming messages are not recorded.	<ul style="list-style-type: none"> <li>• The recording time is set to "Greeting only". Select "1 minute", "2 minutes" or "3 minutes" (p. 29).</li> <li>• Memory is full. Erase unnecessary messages (p. 71).</li> <li>• The Answering System is not turned on for the line you wish to record messages from. Select the desired line or both lines by pressing [<b>LINE SELECT</b>] repeatedly, then turn the Answering System on again (p. 65).</li> </ul>
"FULL" flashes and the ANSWER ON indicator flashes rapidly. No new messages are recorded.	<ul style="list-style-type: none"> <li>• Memory is full. Erase unnecessary messages (p. 71).</li> </ul>
You cannot operate the Answering System from the base unit or the handset.	<ul style="list-style-type: none"> <li>• If another user is listening to messages or the Answering System is handling a call, you cannot operate the Answering System. Try again later.</li> </ul>
You cannot operate the Answering System from a touch tone phone.	<ul style="list-style-type: none"> <li>• Make sure you entered the correct remote code (p. 75).</li> <li>• The Answering System may not respond if the tones are too short to activate the unit. Press each button firmly.</li> <li>• The Answering System is off. Turn it on (p. 65).</li> </ul>
When you play back messages or turn on the Answering System, the base unit and handset announce the wrong day and time.	<ul style="list-style-type: none"> <li>• The date and time may be set incorrectly. Set the date and time again (p. 19).</li> </ul>
Caller ID information is not displayed during message playback (p. 70).	<ul style="list-style-type: none"> <li>• Caller ID information will not be displayed               <ul style="list-style-type: none"> <li>— if a message is recorded by using [<b>MEMO</b>] (p. 72), or</li> <li>— if a call is transferred to the Answering System and the caller leaves a message (p. 73).</li> </ul> </li> </ul>
Although you tried to erase all messages, all messages are not erased.	<ul style="list-style-type: none"> <li>• If you pressed a button to start another operation before you hear "No messages", erasing is stopped. Erase messages again (p. 71, 72).</li> </ul>
The NEW MESSAGE indicator still flashes even if you have listened to all new messages.	<ul style="list-style-type: none"> <li>• The other line has new messages. Select that line by pressing [<b>LINE SELECT</b>], then play back the new messages (p. 67).</li> <li>• If you selected lines to play back messages, memo messages will not be played. Play back messages without selecting lines first (p. 67).</li> </ul>
An incoming message recorded for a line is not played after pressing [ <b>MESSAGE</b> ].	<ul style="list-style-type: none"> <li>• Select the line for that message by pressing [<b>LINE SELECT</b>], then press [<b>MESSAGE</b>] (p. 67).</li> </ul>



# Troubleshooting

Problem	Cause & Remedy
Memo messages are not played after pressing [MESSAGE].	<ul style="list-style-type: none"> <li>You may have pressed [LINE SELECT] before pressing [MESSAGE]. Press [MESSAGE] again without pressing [LINE SELECT] (p. 67).</li> </ul>

## General

Problem	Cause & Remedy
The handset/base unit does not work.	<ul style="list-style-type: none"> <li>Check the settings (p. 11–16).</li> <li>Check whether the dialing mode setting is correct (p. 20).</li> <li>Fully charge the battery (p. 15).</li> <li>Clean the charge contacts and charge again (p. 16).</li> <li>Check battery installation (p. 15).</li> <li>Unplug the base unit's AC adaptor to reset it. Plug in, and try again.</li> <li>Re-install the battery (p. 15) and fully charge it.</li> </ul>
"Recharge battery" is displayed, "■" flashes, or the handset beeps intermittently.	<ul style="list-style-type: none"> <li>Fully charge the battery (p. 15, 16).</li> </ul>
"Charge for 6 HRS" and "■" are displayed and the handset does not work.	<ul style="list-style-type: none"> <li>The battery has been discharged. Fully charge the battery (p. 15, 16).</li> </ul>
You charged the battery fully, but "Recharge battery" is still displayed and/or "■" continues to flash, or "Charge for 6 HRS" and "■" are displayed.	<ul style="list-style-type: none"> <li>Clean the charge contacts and charge again (p. 16).</li> <li>The battery may need to be replaced. If you install a new battery, fully charge it (p. 15, 16).</li> </ul>
The CHARGE indicator does not go out after the battery has been charged.	<ul style="list-style-type: none"> <li>This is normal.</li> </ul>
If you cannot solve your problem	<ul style="list-style-type: none"> <li>Visit our website: <a href="http://www.panasonic.com/consumersupport">http://www.panasonic.com/consumersupport</a></li> <li>Contact us via the web at: <a href="http://www.panasonic.com/contactinfo">http://www.panasonic.com/contactinfo</a></li> <li>Call our customer call center at: 1-800-211-PANA(7262)</li> </ul>

# Important Safety Instructions

---

When using this unit, basic safety precautions should always be followed to reduce the risk of fire, electric shock, or personal injury.

1. Read and understand all instructions.
2. Follow all warnings and instructions marked on this unit.
3. Unplug this unit from AC outlets before cleaning. Do not use liquid or aerosol cleaners. Use a damp cloth for cleaning.
4. Do not use this unit near water, for example, near a bathtub, washbowl, kitchen sink, or the like.
5. Place this unit securely on a stable surface. Serious damage and/or injury may result if the unit falls.
6. Do not cover slots and openings on the unit. They are provided for ventilation and protection against overheating. Never place the unit near radiators, or in a place where proper ventilation is not provided.
7. Use only the power source marked on the unit. If you are not sure of the type of power supplied to your home, consult your dealer or local power company.
8. Do not place objects on the power cord. Install the unit where no one can step or trip on the cord.
9. Do not overload wall outlets and extension cords. This can result in the risk of fire or electric shock.
10. Never push any objects through slots in this unit. This may result in the risk of fire or electric shock. Never spill any liquid on the unit.
11. To reduce the risk of electric shock, do not disassemble this unit. Take the unit to an authorized servicer when service is required. Opening or removing covers may expose you to dangerous voltages or other risks. Incorrect reassembly can cause electric shock when the unit is subsequently used.
12. Unplug this unit from the wall outlet and refer servicing to an authorized servicer when the following conditions occur:
  - A. When the power supply cord or plug is damaged or frayed.
  - B. If liquid has been spilled into the unit.
  - C. If the unit has been exposed to rain or water.
  - D. If the unit does not work normally by following the operating instructions. Adjust only controls covered by the operating instructions. Improper adjustment may require extensive work by an authorized servicer.
  - E. If the unit has been dropped or physically damaged.
  - F. If the unit exhibits a distinct change in performance.
13. During thunderstorms, avoid using telephones except cordless types. There may be a remote risk of an electric shock from lightning.
14. Do not use this unit to report a gas leak, when in the vicinity of the leak.

## SAVE THESE INSTRUCTIONS

# Important Safety Instructions

---

## CAUTION:

To reduce the risk of fire or injury to persons, read and follow these instructions.

1. Use only the battery(ies) specified.
2. Do not dispose of the battery(ies) in a fire. They may explode. Check with local waste management codes for special disposal instructions.
3. Do not open or mutilate the battery(ies). Released electrolyte is corrosive and may cause burns or injury to the eyes or skin. The electrolyte may be toxic if swallowed.
4. Exercise care in handling batteries in order not to short the battery to conductive materials such as rings, bracelets, and keys. The battery and/or conductor may overheat and cause burns.
5. Charge the battery(ies) provided with or identified for use with this product only in accordance with the instructions and limitations specified in this manual.

## WARNING:

**TO PREVENT FIRE OR SHOCK HAZARD, DO NOT EXPOSE THIS PRODUCT TO RAIN OR ANY TYPE OF MOISTURE.**

- The AC adaptor is used as the main disconnect device, ensure that the AC outlet is located/installed near the unit and is easily accessible.

# FCC and Other Information

---

This equipment complies with Part 68 of the FCC rules and the requirements adopted by the ACTA. On the bottom of this equipment is a label that contains, among other information, a product identifier in the format US:ACJ-----.

If requested, this number must be provided to the telephone company.

Registration No. .... (found on the bottom of the unit)  
Ringer Equivalence No. (REN) .....0.2B

A plug and jack used to connect this equipment to the premises wiring and telephone network must comply with the applicable FCC Part 68 rules and requirements adopted by the ACTA. A compliant telephone cord and modular plug is provided with this product. It is designed to be connected to a compatible modular jack that is also compliant.

The REN is used to determine the number of devices that may be connected to a telephone line. Excessive RENs on a telephone line may result in the devices not ringing in response to an incoming call. In most but not all areas, the sum of RENs should not exceed five (5.0). To be certain of the number of devices that may be connected to a line, as determined by the total RENs, contact the local telephone company. For products approved after July 23, 2001, the REN for this product is part of the product identifier that has the format US:AAAEQ##TXXXX. The digits represented by ## are the REN without a decimal point (e.g., 03 is a REN of 0.3).

## FCC and Other Information

---

If this equipment causes harm to the telephone network, the telephone company will notify you in advance that temporary discontinuance of service may be required. But if advance notice isn't practical, the telephone company will notify the customer as soon as possible. Also, you will be advised of your right to file a complaint with the FCC if you believe it is necessary.

The telephone company may make changes in its facilities, equipment, operations or procedures that could affect the operation of the equipment. If this happens the telephone company will provide advance notice in order for you to make necessary modifications to maintain uninterrupted service.

If trouble is experienced with this equipment, for repair or warranty information, please contact a Factory Servicer or other Authorized Servicer. If the equipment is causing harm to the telephone network, the telephone company may request that you disconnect the equipment until the problem is resolved.

Connection to party line service is subject to state tariffs. Contact the state public utility commission, public service commission or corporation commission for information.

If your home has specially wired alarm equipment connected to the telephone line, ensure the installation of this equipment does not disable your alarm equipment. If you have questions about what will disable alarm equipment, consult your telephone company or a qualified installer.

### WHEN PROGRAMMING EMERGENCY NUMBERS AND(OR) MAKING TEST CALLS TO EMERGENCY NUMBERS:

- 1) Remain on the line and briefly explain to the dispatcher the reason for the call.
- 2) Perform such activities in the off-peak hours, such as early morning or late evenings.

This device complies with Part 15 of the FCC Rules. Operation is subject to the following two conditions: (1) This device may not cause harmful interference, and (2) this device must accept any interference received, including interference that may cause undesired operation.

Privacy of communications may not be ensured when using this phone.

### **CAUTION:**

Any changes or modifications not expressly approved by the party responsible for compliance could void the user's authority to operate this device.

### **Note:**

This equipment has been tested and found to comply with the limits for a Class B digital device, pursuant to Part 15 of the FCC Rules. These limits are designed to provide reasonable protection against harmful interference in a residential installation. This equipment generates, uses, and can radiate radio frequency energy and, if not installed and used in accordance with the instructions, may cause harmful interference to radio communications. However, there is no guarantee that interference will not occur in a particular installation. If this equipment does cause harmful interference to radio or television reception, which can be determined by turning the equipment off and on, the user is encouraged to try to correct the interference by one or more of the following measures:

- Reorient or relocate the receiving antenna.
- Increase the separation between the equipment and receiver.
- Connect the equipment into an outlet on a circuit different from that to which the receiver is connected.
- Consult the dealer or an experienced radio/TV technician for help.

## FCC and Other Information

Some cordless telephones operate at frequencies that may cause interference to nearby TVs and VCRs. To minimize or prevent such interference, the base of the cordless telephone should not be placed near or on top of a TV or VCR. If interference is experienced, move the cordless telephone further away from the TV or VCR. This will often reduce, or eliminate, interference.

Operating near 5.8 GHz electrical appliances may cause interference. Move away from the electrical appliances.

### **FCC RF Exposure Warning:**

This product complies with FCC radiation exposure limits set forth for an uncontrolled environment. To comply with FCC RF exposure requirements the base unit must be installed and operated with its antenna located 20 cm or more between antenna and all person's body (excluding extremities of hands, wrist and feet). The handset unit may be carried and operated with only the specific provided belt-clip. Other non-tested belt-clips or similar body-worn accessories may not comply and must be avoided. The base and handset units must not be co-located or operated in conjunction with any other antenna or transmitter.

This equipment is hearing aid compatible as defined by the FCC in 47 CFR Section 68.316.

- **Environment** — do not place the unit in a room where the temperature is less than 5°C (41°F) or greater than 40°C (104°F). Allow 10 cm (4") clearance around the unit for proper ventilation. Avoid excessive smoke, dust, mechanical vibration, shock, or direct sunlight.
- **Medical** — consult the manufacturer of any personal medical devices, such as pacemakers or hearing aids, to determine if they are adequately shielded from external RF (radio frequency) energy. (The unit operates in the frequency range of 5760MHz to 5840MHz, and the power output level can range from 0.25 watts to 0.5 watts.) Do not use the unit in health care facilities if any regulations posted in the area instruct you not to do so. Hospitals or health care facilities may be using equipment that could be sensitive to external RF (radio frequency) energy.
- **Routine care**

# Specifications

---

## ■ Handset

<b>Power Supply:</b>	Ni-MH battery (3.6 V, 830 mAh)
<b>Frequency:</b>	5.76 GHz – 5.84 GHz
<b>Dimensions (H x W x D):</b>	Approx. 220 mm x 53 mm x 37 mm (8 <sup>21</sup> / <sub>32</sub> " x 2 <sup>3</sup> / <sub>32</sub> " x 1 <sup>15</sup> / <sub>32</sub> " )
<b>Mass (Weight):</b>	Approx. 210 g (0.46 lb.)
<b>Security Codes:</b>	1,000,000

## ■ Base Unit

<b>Power Supply:</b>	AC adaptor (120 V AC, 60 Hz)
<b>Power Consumption:</b>	Standby:    Approx. 2.7 W Maximum:   Approx. 6.5 W
<b>Frequency:</b>	5.76 GHz – 5.84 GHz
<b>Dimensions (H x W x D):</b>	Approx. 107 mm x 251 mm x 135 mm (4 <sup>7</sup> / <sub>32</sub> " x 9 <sup>7</sup> / <sub>8</sub> " x 5 <sup>5</sup> / <sub>16</sub> " )
<b>Mass (Weight):</b>	Approx. 520 g (1.15 lb.)

■ **Dialing Mode:**                    Tone (DTMF)/Pulse

■ **Operating Environment:** 5 °C – 40 °C (41 °F – 104 °F)

Specifications are subject to change without notice.

## Energy Star:

As an ENERGY STAR<sup>®</sup> Participant, Panasonic has determined that this product meets the ENERGY STAR guidelines for energy efficiency. ENERGY STAR is a U.S. registered mark.



**PANASONIC CONSUMER  
ELECTRONICS COMPANY, DIVISION  
OF PANASONIC CORPORATION OF  
NORTH AMERICA**  
One Panasonic Way,  
Secaucus, New Jersey 07094

**PANASONIC PUERTO RICO, INC.**  
San Gabriel Industrial Park,  
Ave. 65 de Infantería, Km. 9.5,  
Carolina, Puerto Rico 00985

## **Panasonic Telephone Products Limited Warranty**

### **Limited Warranty Coverage**

If your product does not work properly because of a defect in materials or workmanship, Panasonic Consumer Electronics Company or Panasonic Puerto Rico, Inc. (collectively referred to as "the warrantor") will, for the length of the period indicated on the chart below, which starts with the date of original purchase ("Limited Warranty period"), at its option either (a) repair your product with new or refurbished parts, or (b) replace it with a new or a refurbished product. The decision to repair or replace will be made by the warrantor.

<b>Parts</b>	<b>Labor</b>
<b>One (1) Year</b>	<b>One (1) Year</b>

During the "Labor" Limited Warranty period there will be no charge for labor. During the "Parts" Limited Warranty period, there will be no charge for parts. You must mail-in your product during the Limited Warranty period. This Limited Warranty excludes both parts and labor for batteries, antennas, and cosmetic parts (cabinet). This Limited Warranty only applies to products purchased and serviced in the United States or Puerto Rico. This Limited Warranty is extended only to the original purchaser and only covers products purchased as new.

### **Mail-In Service**

For assistance in the continental U.S.A. in obtaining repairs please ship the product to:

**Panasonic Services Company Customer Servicenter**  
**4900 George McVay Drive Suite B Door #12 McAllen, TX 78503**

✂ For assistance in Puerto Rico call Panasonic Puerto Rico, Inc. (787)-750-4300 or fax (787)-768-2910.

For Limited Warranty service for headsets if a headset is included with this product please call Panasonic Call Center at 1-800-211-PANA (7262).

When shipping the unit carefully pack, include all accessories, and send it prepaid, adequately insured and preferably in the original carton. Include a letter detailing the complaint and provide a day time phone number where you can be reached.

**IF REPAIR IS NEEDED DURING THE LIMITED WARRANTY PERIOD THE PURCHASER WILL BE REQUIRED TO FURNISH A SALES RECEIPT/PROOF OF PURCHASE INDICATING DATE OF PURCHASE, AMOUNT PAID AND PLACE OF PURCHASE. CUSTOMER WILL BE CHARGED FOR THE REPAIR OF ANY UNIT RECEIVED WITHOUT SUCH PROOF OF PURCHASE.**

### **Limited Warranty Limits And Exclusions**

This Limited Warranty ONLY COVERS failures due to defects in materials or workmanship, and DOES NOT COVER normal wear and tear or cosmetic damage. The Limited Warranty ALSO DOES NOT COVER damages which occurred in shipment, or failures which are caused by products not supplied by the warrantor, or failures which result from accidents, misuse, abuse, neglect, mishandling, misapplication, alteration, faulty installation, set-up adjustments, misadjustment of consumer controls, improper maintenance, power line surge, lightning damage, modification, introduction of sand, humidity or liquids, commercial use such as hotel, office, restaurant, or other business or rental use of the product, or service by anyone other than a Factory Servicenter or other Authorized Servicer, or damage that is attributable to acts of God.

**THERE ARE NO EXPRESS WARRANTIES EXCEPT AS LISTED UNDER "LIMITED WARRANTY COVERAGE". THE WARRANTOR IS NOT LIABLE FOR INCIDENTAL OR CONSEQUENTIAL DAMAGES RESULTING FROM THE USE OF THIS PRODUCT, OR ARISING OUT OF ANY BREACH OF THIS LIMITED WARRANTY.** (As examples, this excludes damages for lost time, lost calls or messages, cost of having someone remove or re-install an installed unit if applicable, travel to and from the servicer. The items listed are not exclusive, but are for illustration only.) **ALL EXPRESS AND IMPLIED WARRANTIES, INCLUDING THE WARRANTY OF MERCHANTABILITY, ARE LIMITED TO THE PERIOD OF THE LIMITED WARRANTY.**

Some states do not allow the exclusion or limitation of incidental or consequential damages, or limitations on how long an implied warranty lasts, so the exclusions may not apply to you. This Limited Warranty gives you specific legal rights and you may also have other rights which vary from state to state. If a problem with this product develops during or after the Limited Warranty period, you may contact your dealer or Servicenter. If the problem is not handled to your satisfaction, then write to the warrantor's Consumer Affairs Department at the addresses listed for the warrantor.

**PARTS AND SERVICE, WHICH ARE NOT COVERED BY THIS LIMITED WARRANTY, ARE YOUR RESPONSIBILITY.**

## ***Customer Services Directory***

Obtain Product Information and Operating Assistance; locate your nearest Dealer or Servicenter; purchase Parts and Accessories; or make Customer Service and Literature requests by visiting our Web Site at:

**<http://www.panasonic.com/consumersupport>**

or, contact us via the web at:

**<http://www.panasonic.com/contactinfo>**

You may also contact us directly at: 1-800-211-PANA (7262),  
Monday-Friday 9 am-9 pm; Saturday-Sunday 10 am-7 pm, EST.

For hearing or speech impaired TTY users, TTY : 1-877-833-8855

## ***Accessory Purchases***

Purchase Parts, Accessories and Instruction Books online for all Panasonic Products by visiting our Web Site at:

**<http://www.pasc.panasonic.com>**

or, send your request by E-mail to:

**[npcparts@us.panasonic.com](mailto:npcparts@us.panasonic.com)**

You may also contact us directly at:

1-800-332-5368 (Phone) 1-800-237-9080 (Fax Only)  
(Monday - Friday 9 am to 8 pm, EST.)

Panasonic Services Company

20421 84th Avenue South, Kent, WA 98032

(We Accept Visa, MasterCard, Discover Card, American Express,  
and Personal Checks)

For hearing or speech impaired TTY users, TTY : 1-866-605-1277

## ***Service in Puerto Rico***

***Panasonic Puerto Rico, Inc.***

***San Gabriel Industrial Park, Ave. 65 de Infantería, Km. 9.5,***

***Carolina, Puerto Rico 00985***

***Phone (787)750-4300, Fax (787)768-2910***



# Index

- A**
  - Accessories . . . . . 2
  - Answering calls, base unit . . . . . 38
  - Answering calls, handset . . . . . 38
  - Answering System . . . . . 65
  - Auto talk . . . . . 22, 38, 53
- B**
  - Backlit LCD . . . . . 34
  - Base unit location . . . . . 6
  - Battery charge . . . . . 15
  - *Battery information* . . . . . 16
  - Battery replacement . . . . . 15, 16
  - Battery strength . . . . . 15
  - Belt clip . . . . . 81
  - *Booster* . . . . . 35
- C**
  - Call share . . . . . 57
  - Call Waiting Caller ID display . . . . . 59
  - Call waiting tone . . . . . 59
  - *Caller ID number auto edit* . . . . . 43, 44
  - *Call monitoring* . . . . . 66
  - Caller ID service . . . . . 40
  - Caller List, editing . . . . . 43
  - Caller List, erasing . . . . . 45
  - Caller List, storing . . . . . 45
  - Caller List, viewing . . . . . 41
  - Calling back from the Caller List . . . . . 42
  - *Chain dial* . . . . . 49
  - CID (Caller ID) . . . . . 40
  - *Clarity booster* . . . . . 35
  - CONF (Conference) . . . . . 56
  - Conference calls . . . . . 56
- D**
  - *Date and time* . . . . . 19
  - Dialing mode . . . . . 20
  - Direct commands . . . . . 82, 83
  - Displays . . . . . 9
  - Display language . . . . . 20
- E**
  - Erasing messages . . . . . 71
  - Erasing all messages . . . . . 71
- Error messages . . . . . 84
- F**
  - FCC and other information . . . . . 91
  - FLASH button . . . . . 60
  - Flash time . . . . . 60
  - *Function menu, Direct commands* . . . . . 82, 83
  - Function menu, selection . . . . . 17
  - Function menu, table . . . . . 18
- G**
  - *Greeting message* . . . . . 27
- H**
  - Headset, optional . . . . . 81
  - Hold . . . . . 34, 37
- I**
  - Incoming call tone . . . . . 61
  - Installation, AC adaptor . . . . . 11
  - Installation, battery . . . . . 15
  - Installation, telephone line cord . . . . . 12, 13
  - Intercom call . . . . . 52
- K**
  - Key tone . . . . . 63
- L**
  - LCD contrast . . . . . 22
  - Lighted handset keypad . . . . . 34
  - Line mode . . . . . 21
  - LINE SELECT button . . . . . 24, 27, 65, 66, 67, 71
  - Line selection . . . . . 62
  - Listening to messages . . . . . 67, 68, 74
  - Location of controls . . . . . 6, 7

# Index

---

## M

- Mailbox, transferring a call . . . . . 73
- Making calls, base unit . . . . . 36
- Making calls, handset . . . . . 32
- Memo message . . . . . 72
- Message alert . . . . . 31, 67
- Message storage . . . . . 28
- Microphone, base unit . . . . . 27, 36, 52
- Microphone, handset . . . . . 32
- Monitoring incoming calls . . . . . 66
- Mute . . . . . 58

## N

- Navigator key . . . . . 8
- Noise . . . . . 3
- Number of rings . . . . . 30

## P

- Paging . . . . . 52
- PAUSE . . . . . 58
- Phone book . . . . . 46
- Phone book, dialing . . . . . 47, 49
- Phone book, editing . . . . . 50
- Phone book, erasing . . . . . 50
- Phone book, names . . . . . 47
- Phone book, storing . . . . . 46
- Power failure . . . . . 11, 19, 28
- Privacy feature . . . . . 58
- Pulse service . . . . . 59

## R

- Recording mode . . . . . 31
- Recording time . . . . . 29
- Redial . . . . . 33, 37
- Redial list . . . . . 34
- Registration . . . . . 64
- Remote code . . . . . 75
- Remote operation, handset . . . . . 68
- Remote operation, touch tone phone . . . . . 74
- Ringer off . . . . . 23, 24, 38
- Ringer tone . . . . . 25, 26
- Ringer volume . . . . . 23, 24
- Rotary service, tone dialing . . . . . 59

## S

- Safety instructions . . . . . 90
- Shipping product for service . . . . . Back cover
- Soft keys . . . . . 8
- Speed dialer . . . . . 51
- Specifications . . . . . 94
- SP-phone, base unit . . . . . 36
- SP-phone, handset . . . . . 32

## T

- Toll saver . . . . . 30
- Transferring a call . . . . . 54, 73
- Troubleshooting, Answering System . . . . . 88
- Troubleshooting, general . . . . . 89
- Troubleshooting, Telephone System . . . . . 85
- TTY . . . . . 2, 96, Back Cover

## V

- VE (Voice Enhancer) . . . . . 35
- Voice enhancer technology . . . . . 35
- Voice menu . . . . . 69, 76
- Volume control, base unit . . . . . 28, 36, 70
- Volume control, handset . . . . . 33, 70

## W

- Wall mounting . . . . . 78
- Warranty . . . . . 95

- “–” indicates important information and frequently used features.



## For product service

- Visit our website: <http://www.panasonic.com/consumersupport>
- Contact us via the web at: <http://www.panasonic.com/contactinfo>
- Call us at: 1-800-211-PANA(7262)

## When you ship the product

- Carefully pack your unit, preferably in the original carton.
- Attach a letter, detailing the symptom, to the outside of the carton.

Symptom

---

- Send the unit to an authorized servicenter, prepaid and adequately insured.
- Do not send your unit to the Panasonic Consumer Electronics Company listed below or to executive or regional sales offices. These locations do not repair consumer products.

## For your future reference

Serial No.

Date of purchase

---

(found on the bottom of the unit)

Name and address of dealer

---

- This cordless telephone is designed for use in the United States of America. Sale or use of this product in other countries may violate local laws.
- Ce téléphone sans fil est conçu pour être utilisé aux États-Unis d'Amérique. La vente ou l'emploi de cet appareil dans certains autres pays peut constituer une infraction à la législation locale.
- Este teléfono inalámbrico fue elaborado para uso en los Estados Unidos de América. La venta o el empleo de este producto en ciertos países puede constituir violación de la legislación local.
- このコードレス電話機は、日本国外での使用を目的として設計されており、日本国内での使用は法律違反となります。従って、当社では日本国内においては原則として修理などのサービスは致しかねます。

**If you need assistance with setup or operation, please call 1-800-211-PANA(7262)**

**For hearing or speech impaired TTY users, TTY : 1-877-833-8855**

**Panasonic Consumer Electronics Company,  
Division of Panasonic Corporation of North America**  
One Panasonic Way, Secaucus, New Jersey 07094

**Panasonic Puerto Rico, Inc.**

San Gabriel Industrial Park, Ave. 65 de Infantería, Km. 9.5,  
Carolina, Puerto Rico 00985